

ink[®]

*De kranen van IVY[®]
matchen perfect
met INK[®]!*

*The faucets from IVY[®] are
matching perfectly
with INK[®]!*



Ontdek de nieuwste collecties INK[®] badkamermeubelen, spiegels en fonteinen. Uniek én altijd uit voorraad leverbaar.

Discover the latest collections of INK[®] bathroom furniture, mirrors and hand washbasins. Unique and always available from stock.

Sanibell The Netherlands
Ferrarilaan 8
3261 NC Oud-Beijerland
Nederland
www.sanibell.nl
info@sanibell.nl
+31 186 657 347

Sanibell Belgium
Sluis 2A unit 2
9810 Eke, Nazareth
België
www.sanibell.be
info@sanibell.be

International
www.sanibell.nl
export@sanibell.nl



NL | EN 2024.2

Alle maten in deze brochure zijn aangegeven in centimeters.

De in deze brochure afgebeelde kleuren en foto's geven een indicatie van de werkelijkheid. Een afwijking is mogelijk. Kleurstalen kunt u bekijken bij de INK-dealers of bestellen via de website van Sanibell (www.sanibell.nl). Alle overige gegevens in deze brochure zijn met de grootst mogelijke zorgvuldigheid bijeengebracht en gecontroleerd. Voor eventuele fouten of onvolledigheden en de gevolgen daarvan wordt geen aansprakelijkheid aanvaard. In het belang van vernieuwingen en verbeteringen behouden wij het recht voor wijzigingen in producten aan te brengen.

All dimensions in this brochure are given in centimetres.

The colours and photos shown in this brochure give an indication of reality. A deviation is possible. Colour samples can be viewed at the INK dealers or ordered on the Sanibell website (www.sanibell.nl). All other information in this brochure has been collected and checked with the greatest possible care. No liability is accepted for any errors or omissions and the consequences thereof. In the interest of innovations and improvements, we reserve the right to make changes to products.

Inhoud

Table of content

Over INK / About INK

- 004 ----- **Het merk INK** *The INK Brand*
- 010 ----- **Inspiration & Experience Center** *Inspiration & Experience Center*
- 011 ----- **Kranen en meer** *Faucets and more*

Producten / Products

- 014 ----- **Collectie 40 cm diep** *Furniture 40 cm depth*
- 032 ----- **Collectie 45 cm diep** *Furniture 45 cm depth*
- 082 ----- **Collectie 48 cm diep** *Furniture 48 cm depth*
- 089 ----- **Wandplanken** *Wall shelves*
- 090 ----- **(half) Hoge kasten** *(semi) Tall cabinets*
- 092 ----- **Spiegelkasten & spiegels** *Mirror cabinets & mirrors*
- 097 ----- **Verlichting** *Lighting*
- 098 ----- **Collectie fonteinen** *Collection hand washbasins*
- 135 ----- **Fonteinspiegels** *Hand washbasins mirrors*
- 139 ----- **Fonteinkranen en accessoires** *Coldwater taps & accessories*

Ons verhaal / Our story

- 140 ----- **Het verhaal achter INK** *The story behind INK*

Materialen / Materials

- 142 ----- **Materiaal & onderhoud** *Material & maintenance*
- 154 ----- **Index & legenda** *Index & legend*



Creëer het ideale middelpunt in de badkamer met het mooiste INK badkamermeubel

In deze brochure vindt u een uitgebreid overzicht van onze series INK badkamermeubelen en kunt u ideeën opdoen voor de samenstelling van uw INK meubel en de inrichting van uw eigen badkamer en toilet.

Met keuze uit meer dan 27 verschillende typen wastafels en waskommen, ruim 10 decorkleuren, 4 eiken fineerkleuren, 4 massief eiken kleuren en 16 typen onderkasten kunt u uitgebreid gaan combineren. In deze brochure laten we ook zien wat er mogelijk is met kleur, ruimte, formaat, comfort en sfeer. Het gaat u zeker helpen om een goede, creatieve en verantwoorde keuze voor de badkamer te maken. Ook voor het kleinste kamertje van het huis zijn er tientallen creatieve fonteinopstellingen voorhanden.

Create the ideal focal point in the bathroom with the most beautiful INK bathroom furniture

In this brochure you will find an extensive overview of our INK bathroom furniture series and you can get ideas for the composition of your INK furniture and the design of your own bathroom and toilet.

With a choice of more than 27 different types of washbasins and wash bowls, more than 10 decor colours, 4 oak veneer colours, 4 solid oak colours and 16 types of base cabinets, you can combine extensively. In this brochure we also show what is possible with colour, space, size, comfort and atmosphere. It will certainly help you to make a good, creative and responsible choice for the bathroom. There are also dozens of creative hand washbasin arrangements available for the smallest room in the house.

Onderhoud

Wat mooi is moet mooi blijven. We hebben een compleet assortiment onderhoudsproducten beschikbaar voor onze meubelen en wastafels. Alle belangrijke informatie en tips over het onderhoud van de verschillende materialen vindt u op de website. De onderhoudsproducten worden via onze website of via uw sanitair specialist verkocht. Neem voor meer informatie en/of aankoop van deze producten contact op met uw INK dealer of ga rechtstreeks naar: www.sanibell.nl/shop

Maintenance

What is beautiful must remain beautiful. We have a complete range of maintenance products available for our furniture and washbasins. You can find all important information and tips about the maintenance of the different materials on the website. The maintenance products are sold via our website or via your bathroom retailer. For more information and/or purchase of these products, please contact your INK dealer or go directly to: www.sanibell.nl/webshop

Alle combinaties uit voorraad leverbaar

Over de levertijden hoeft u zich geen zorgen te maken. We hebben alles op voorraad staan in onze magazijnen. Mocht u twijfelen over de levertijd dan is een telefoontje met onze afdeling verkoop voldoende om u ervan te overtuigen dat het ook werkelijk beschikbaar is. Dus over levertijden hoeft u zich geen zorgen te maken. Succes met kiezen en combineren. U gaat er per slot van rekening lang van genieten!

All INK products are available from stock

You don't have to worry about delivery times. We have everything in stock in our warehouses. If you have any doubts about the delivery time, a phone call to our sales department will be enough to convince you that it is actually available.

So you do not have to worry about delivery times. Good luck with choosing and combining. After all, you will enjoy it for a long time!





Service staat hoog in ons vaandel

We geven een zeer hoge prioriteit aan de tevredenheid van onze klanten. Dat staat hoog in ons vaandel en daar handelen wij ook naar. Heeft u een servicevraag of aanmerking op het meubel? De INK dealers hebben vaak een goede oplossing maar zullen u altijd vragen om de eventuele op- of aanmerking te voorzien van foto's. Dat maakt altijd meer duidelijk en versnelt het serviceproces. De medewerkers van de INK serviceafdeling hebben als opdracht om de belangen van u als klant als belangrijkste uitgangspunt te nemen en daar de meest optimale service voor te verlenen. Zij worden pas blij als u dat ook bent. Daar kunt u als klant op rekenen.

Op alle badkamermeubelen van INK geldt bovendien een garantietermijn van 5 jaar. Dat is eveneens één van de redenen waarom wij standaard hebben gekozen voor de hoogwaardige kwaliteit van de materialen en systemen. Ook vindt u op de website uitgebreide informatie over hoe de meubelen en wastafels te onderhouden en te installeren zijn.

Service is our top priority

We give the satisfaction of our customers a very high priority. This is our top priority and we act accordingly. Do you have a service question or comment on the furniture? The INK dealers often have a good solution but will always ask you to provide any comment or comment with photos. This always makes things clearer and speeds up the service process. The employees of the INK service department have the task of taking your interests as the customer as the most important starting point and providing the most optimal service for this. They are only happy when you are too. You can count on that as a customer.

Furthermore, all INK bathroom furniture has a 5-year warranty. This is also one of the reasons why we have opted for the high quality of the materials and systems as standard. You will also find extensive information on the website about how to maintain and install the furniture and washbasins.



De mooiste materialen worden gecombineerd met de meest innovatieve functionaliteiten

De INK collectie onderscheidt zich in diversiteit en beweegt zich al jaren in de top van de badkamermeubelen met kwalitatief design, functionele stijl, innovatieve details en betaalbare kwaliteit. Onze gelakte meubelen met de greeploze 45 graden afwerking zijn hier een prachtig en succesvol voorbeeld van. De diversiteit aan kleuren dragen zeker bij aan dit succes. Het scala aan houtdecorkeuren in het assortiment zijn ook geweldig ruim te noemen. De niet van echt hout te onderscheiden houtdecors zijn van hoogstaande kwaliteit en design. Ook het echte hout in massief en fineer is standaard in het assortiment vertegenwoordigd in vier kleuren! De interieurs van de badkamermeubelen zijn voorzien van de allerbeste ladensystemen en scharnieren.

The most beautiful materials are combined with the most innovative functionalities

The INK collection distinguishes itself in diversity and has been at the top of bathroom furniture for years with high-quality design, functional style, innovative details and affordable quality. Our lacquered furniture with the handleless 45 degree finish is a beautiful and successful example of this. The diversity of colours certainly contributes to this success. The variety of wood decor colours in the range is also wonderfully wide. The wood decors that are indistinguishable from real wood are of high quality and design. But real wood in solid and veneer is also represented in the range in four colours as standard! The interiors of the bathroom furniture are equipped with the very best drawer systems and hinges.

Passie voor vormgeving

De afdeling productdesign- en ontwikkeling bedenkt, ontwerpt en ontwikkelt alle INK® producten volledig in eigen huis. Van eerste schetsontwerp tot finale werktekening. We hebben nu eenmaal een bijzondere passie voor vormgeving en dat vindt zijn weerslag in onze producten.

Passion for design

The product design and development department conceives, designs and develops all INK® products entirely in-house. From the first sketch design to the final working drawing. We simply have a special passion for design and that is reflected in our products.



Hoogwaardige en duurzame materialen

Alle badkamermeubelen zijn gemaakt van hoogwaardige en duurzame materialen en standaard uitgerust met kwalitatieve softclosing ladensystemen. De wastafels en fonteinën zijn gemaakt van polystone, quartz, porselein, keramische slabs of marmer en verkrijgbaar in verschillende moderne glanzende en matte kleuren.

High-quality and sustainable materials

All bathroom furniture is made of high-quality and sustainable materials and equipped as standard with high-quality soft-closing drawer systems. The washbasins and small hand washbasins are made of polystone, quartz, porcelain, ceramic slabs or marble and are available in various modern glossy and matt colours.



Echt Italiaans porselein. Slank en schitterend

Het overgrote deel van onze porseleinen wastafels komt uit Italië. Het land waar al sinds 1740 porselein wordt geproduceerd. De INK® porseleinen wastafels zijn volgens eigen ontwerp en met heel veel vakmanschap in eigen mallen gemaakt. De Italiaanse wastafels zijn voorzien van een 'Ceramics of Italy'-logo, een kwaliteitskeurmerk dat ontwikkeld is door de Italiaanse overheid om de authenticiteit van het Italiaanse porselein te waarborgen.

Genuine Italian porcelain. Sleek and beautiful

The vast majority of our porcelain washbasins come from Italy. The country where porcelain has been produced since 1740. The INK® porcelain washbasins are made according to our own design and with great craftsmanship in our own molds. The Italian washbasins are provided with a 'Ceramics of Italy' logo, a quality hallmark developed by the Italian government to guarantee the authenticity of Italian porcelain.

Bezoek ons Inspiration & Experience Center

Uw badkamer/sanitair adviseur presenteert een selectie van de verschillende merken uit het Sanibell badkamermeubelprogramma. In deze programma's zijn verschillende maten, kleuren en materialen ruim vertegenwoordigd. Wilt u naast deze selectie kennismaken met een ander meubel, een andere uitvoering of een andere kleur uit de collectie, dan bent u ook van harte uitgenodigd in het Sanibell Experience & Inspiration Center in Nederland of België.

Onder begeleiding van een deskundige Sanibell adviseur kunt u daar de meest ideale opstelling maken en kennismaken met de nieuwste decors, kleuren, structuren en uitvoeringen. Een afspraak is zo gemaakt. Ga naar de website en maak een vrijblijvende afspraak via de button 'showroom bezoek'.

Visit our Inspiration & Experience Center

Your bathroom/sanitaryware adviser will present a selection of the various brands in the Sanibell bathroom furniture range. Different sizes, colours and materials are widely represented in these programmes. If, in addition to this selection, you would like to get to know a different piece of furniture, a different design or a different colour from the collection, you are also cordially invited to the Sanibell Experience & Inspiration Centre in the Netherlands or Belgium.

Under the guidance of an expert Sanibell advisor, you can make the most ideal arrangement there and get to know the latest decors, colours, structures and versions. An appointment is easy to make. Go to the website and make a no-obligation appointment via the 'showroom visit' button.



Ferrarilaan 8
3261 NC Oud-Beijerland

Openingstijden Nederland:

Maandag t/m vrijdag van 09:00 - 12:30 uur
en van 13:00 tot 16:00 uur.

Opening hours The Netherlands:

Monday to Friday, 09:00 - 12:30 and
13:00 to 16:00 uur.

Sluis 2A Unit 2
9810 Eke, Nazareth

Openingstijden België:

Maandag t/m vrijdag van 10:00 - 12:30 uur
en van 13:00 tot 16:00 uur.

Opening hours Belgium:

Monday to Friday, 10:00 - 12:30 and
13:00 to 16:00 uur.

Alle verkoop transacties verlopen altijd via de dealer van uw keuze. Sanibell zal ook aan deze dealer terugkoppeling geven over uw wensen en bezoek.

All sales transactions always go through the dealer of your choice. Sanibell will also provide feedback to this dealer about your requirements and visit.

Kleurstalen

De keuze uit kleuren is enorm. Wilt u zeker weten dat de kleur van uw meubel past bij de gekozen tegel of mooi staat in uw badkamer, vraag dan een gratis kleurstaal aan via de website.

Colour samples

The choice of colours is enormous. If you want to be sure that the colour of your furniture matches the chosen tile or looks good in your bathroom, request a free colour sample via the website.

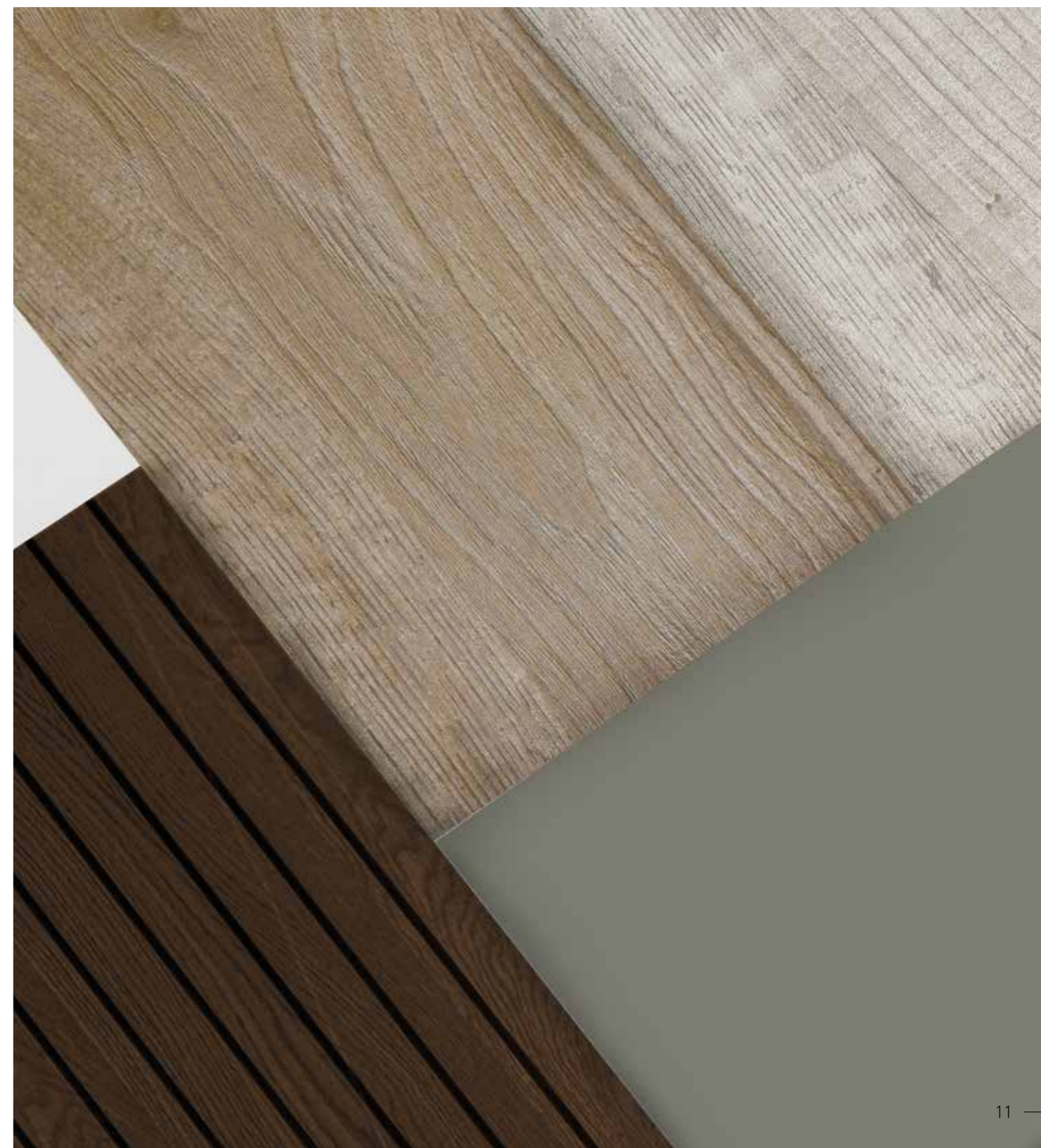



IVY® badkamerkranen matchen perfect met INK®

Bent u ook op zoek naar badkamerkranen die perfect matchen met de spiegels en meubelen binnen INK? Er zijn tal van mogelijkheden binnen ons badkamer-kranenmerk IVY. Ons exclusieve merk IVY heeft grote kleurovereenkomsten met de spiegelkleuren van INK en passen daardoor perfect. Maar ook in stijl en vormgeving sluit IVY helemaal aan op de collecties van INK. Uw badkamer wordt geweldig!

IVY® bathroom taps match INK® perfectly

Are you also looking for faucets that perfectly match the mirrors and furniture within INK? There are plenty of options within our bathroom faucet brand IVY. Our exclusive brand IVY has great colour similarities with INK's mirror colours and therefore fits perfectly. But IVY also matches INK's collections in style and design. Your bathroom will be wonderful!

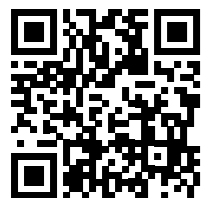

Méér INK® met de maatwerkoplossingen van Bliss®.

Komt u er met de vaste maten, kleuren en uitvoeringen binnen de collecties van INK niet helemaal uit? Ontwerp dan samen met uw sanitairspecialist uw perfecte maatwerk badkamermeubel. Misschien overweegt u de plaatsing van het meubel in een nis, tussen twee muren of staand op de vloer. Met Bliss vervullen wij ook graag uw creatieve en uitdagende wensen. Vraag gerust naar de uitgebreide mogelijkheden. Er is méér mogelijk dan u denkt.

More INK® with Bliss® custom-made solutions.

Are you not quite comfortable with the fixed sizes, colours and designs within INK's collections? Then design your perfect custom-made bathroom furniture together with your sanitary specialist. Perhaps you are considering installing the furniture in a niche, between two walls or standing on the floor. With Bliss, we are also happy to fulfil your creative and challenging wishes. Feel free to ask about the extensive possibilities. More is possible than you think.

Kleuruitvoering serie Concord en Tribe



RVS316 geborsteld RVS316 geborsteld mat goud PVD RVS316 geborsteld mat koper PVD RVS316 geborsteld carbon black PVD

Kleuruitvoering serie Bond & Pact



Chroom Mat zwart PED Geborsteld nickel PVD Geborsteld mat goud PVD Geborsteld mat koper PVD Geborsteld metal black PVD Zwart chroom PVD

40

Collectie
Collection





Klein maar fijn

De Dock, Roots, Reflekt en Unit zijn speciaal ontworpen voor de kleinere badkamer. Door de ondiepe afmetingen van slechts 40 centimeter ontstaat er vanzelf meer bewegingsruimte in de badkamer. De ruimtelijke werking van het ondiepe meubel met prachtige houtstructuren geven de badkamer een moderne uitstraling.

Small is beautiful

The Dock, Roots, Reflekt and Unit are specially designed for the smaller bathroom. The shallow cabinets of only 40 centimetres of depth create more room for movement in the bathroom. The spatial effect of the shallow cabinets with beautiful wood structures gives the bathroom a modern look.

ROOTS 40 cm diep - wastafel porselein glans wit 100 cm - onderkast 2 laden greeploos fineer eiken charcoal - spiegel SP15 mat zwart ø100 cm - 2x hanglamp LED 009 mat zwart

ROOTS 40 cm depth - washbasin porcelain gloss white 100 cm - cabinet 2 drawers handleless veneer oak charcoal - mirror SP15 matt black ø100 cm - 2x pendant lamp LED 009 matt black





REFLEKT 40 cm diep - wastafel midden
 polystone mat wit 120 cm - onderkast 2
 laden greeploos gelakt mat wit - spiegel
 SP30 geborsteld mat koper - kraan IVY Bond
 geborsteld mat koper

REFLEKT 40 cm depth - washbasin middle
 polystone matt white 120 cm - cabinet 2
 drawers handleless lacquered matt white - mirror SP30
 brushed matt copper - faucet IVY Bond brushed
 matt copper

Houten keerlijst

De onderkasten met houten keerlijst passen in iedere badkamer. De houten keerlijst zorgt namelijk voor een stijlvolle en strakke vormgeving.

Wooden rim

The cabinets with wooden rim are suitable for any bathroom. The wooden rim provides a stylish and sleek design.



UNIT 40 cm diep - wastafel glans wit 120 cm - onderkast 2 laden greeploos houten keerlijst houtschool eiken - spiegel SP14 - 3x wandplank 20 cm diep houtschool eiken - 2x wandlamp LED 008 mat zwart

UNIT 40 cm depth - washbasin gloss white 120 cm - cabinet 2 drawers handleless wooden rim charcoal oak - mirror SP14 - 3x wall shelf depth 20 cm charcoal oak - 2x wall lamp LED 008 matt black



DOCK 40 cm diep - wastafel polystone mat wit
120 cm - onderkast 2 laden greeploos gelakt mat
kasjmier grijs - spiegel SP25 Ø100 cm

DOCK 40 cm depth - washbasin polystone matt white
120 cm - cabinet 2 drawers handleless lacquered
matt kasjmier grey - mirror SP25 Ø100 cm



TOPDECK 40 cm diep - opbouwkom Jazz
Small polystone mat wit - onderkast 2 laden
grieploos houten keerlijst greige eiken 80 cm -
afdekplaat greige eiken - spiegelkast SPK2 met
onderverlichting

TOPDECK 40 cm depth - countertop washbasin
Jazz Small polystone matt white - cabinet with
2 drawers handleless wooden rim greige oak
80 cm - cover plate greige oak - mirror cabinet
SPK2 with under lighting





40 CM DIEP / 40 CM DEPTH

WASTAFELS 40 CM DIEP

WASHBASINS 40 CM DEPTH



40 | REFLEKT Polystone Pag. 28



40 | DOCK Polystone | Quartz Pag. 28



40 | ROOTS Porselein
Porcelain Pag. 29



40 | UNIT Porselein
Porcelain Pag. 29



40 | TOPDECK Pag. 30

ONDERKASTEN 40 CM DIEP

CABINETS 40 CM DEPTH



40 | AFDEKPLAAT 2 CM
40 | COVER PLATE 2 CM

Pag. 30



40 | GREEPLOOS HOUTEN KEERLIJST
40 | HANDLELESS WOODEN RIM

2 LADEN | 2 DRAWERS Pag. 31



40 | GREEPLOOS GELAKT
40 | HANDLELESS LAQUERED

2 LADEN | 2 DRAWERS Pag. 31



40 | GREEPLOOS FINEER
40 | HANDLELESS VENEER

2 LADEN | 2 DRAWERS Pag. 31

40 | REFLEKT

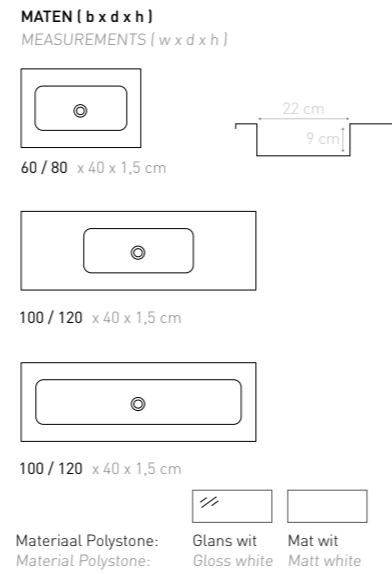

Deze wastafel is verkrijgbaar met of zonder kraangaten.
This washbasin is available with or without tap holes.

40 | ROOTS

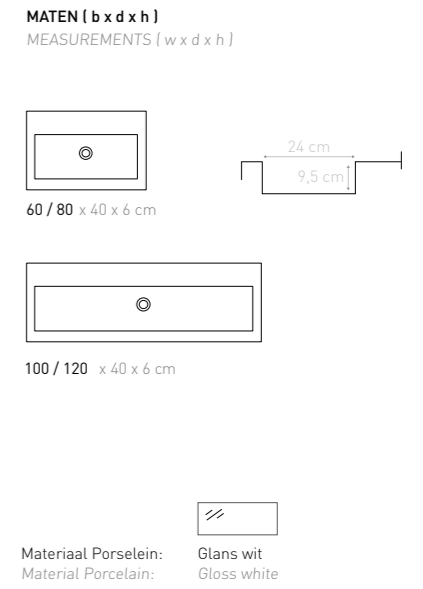

Deze wastafel is verkrijgbaar met of zonder kraangaten.
This washbasin is available with or without tap holes.



40 | DOCK

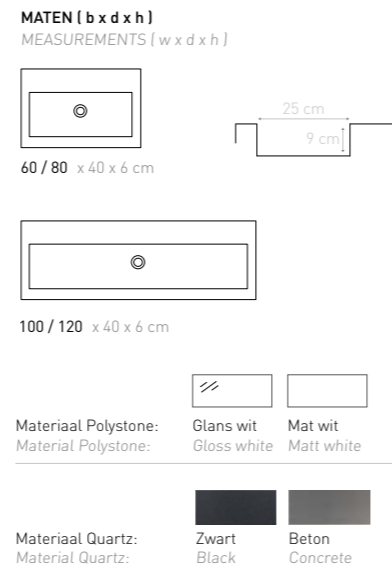

Deze wastafel is verkrijgbaar met of zonder kraangaten.
This washbasin is available with or without tap holes.

40 | UNIT

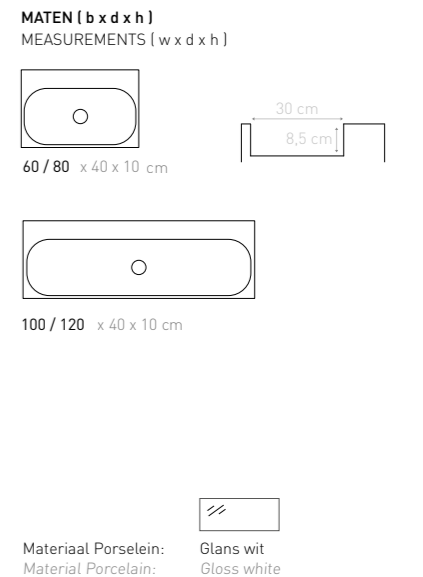

Deze wastafel is verkrijgbaar met of zonder kraangaten.
incl. clickplug in de kleur van wastafel.

This washbasin is available with or without tap holes.
incl. click plug in the colour of the washbasin.



40 | TOPDECK OPBOUW WASTAFELS

40 | TOPDECK COUNTERTOP WASHBASINS



SPIRIT
45 x 24 x 12 cm
Porselein Porcelain



Glans wit
Gloss white



SWING
45 x 34 x 12 cm
Porselein Porcelain



Glans wit
Gloss white

Deze opbouw wastafel is alleen verkrijgbaar met één kraangat.

This countertop washbasin is only available with one tap hole.



JAZZ SMALL
ø 33 x 12 cm
Polystone | Quartz



Glans wit
Gloss white



Mat wit
Matt white

Materiaal Polystone:
Material Polystone:

Materiaal Quartz:
Material Quartz:



Zwart
Black



Beton
Concrete

40 | AFDEKPLAAT 2 CM

40 | COVER PLATE 2 CM

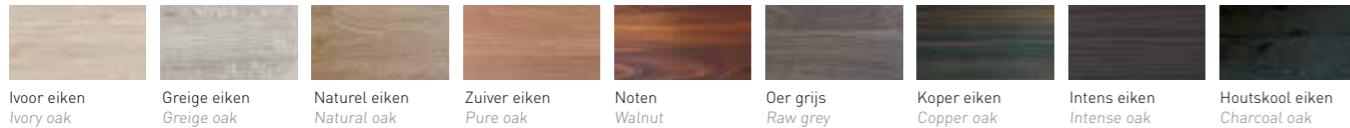

Ivoor eiken
Ivory oak
Greige eiken
Greige oak
Naturel eiken
Natural oak
Zuiver eiken
Pure oak
Noten
Walnut
Oer grijs
Raw grey
Koper eiken
Copper oak
Intens eiken
Intense oak
Houtskool eiken
Charcoal oak

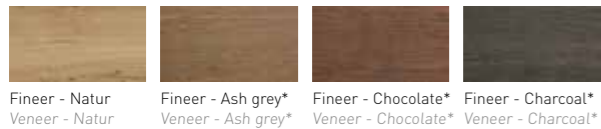

Fineer - Natur
Veneer - Natur
Fineer - Ash grey*
Veneer - Ash grey*
Fineer - Chocolate*
Veneer - Chocolate*
Fineer - Charcoal*
Veneer - Charcoal*

MATEN (b x d) MEASUREMENTS (w x d) 60 / 80 / 100 / 120 x 40 cm

*Coloured by Rubio Monocoat

40 | GREEPLOOS HOUTEN KEERLIJST

40 | HANDLELESS WOODEN RIM

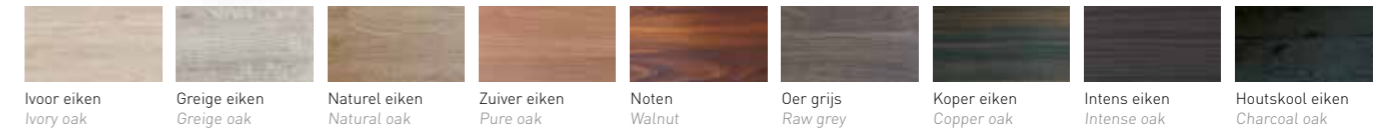
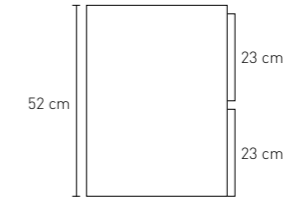

Ivoor eiken
Ivory oak
Greige eiken
Greige oak
Naturel eiken
Natural oak
Zuiver eiken
Pure oak
Noten
Walnut
Oer grijs
Raw grey
Koper eiken
Copper oak
Intens eiken
Intense oak
Houtskool eiken
Charcoal oak

MATEN (b x d) MEASUREMENTS (w x d) 60 / 80 / 100 / 120 x 40 cm



40 | GREEPLOOS GELAKT

40 | HANDLELESS LACQUERED

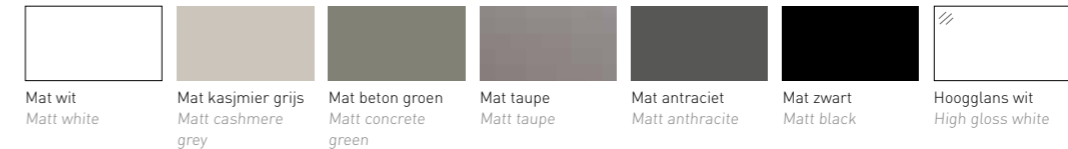
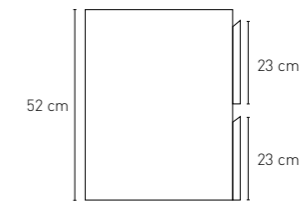

Mat wit
Matt white
Mat kasjmier grijs
Matt cashmere grey
Mat beton groen
Matt concrete green
Mat taupe
Matt taupe
Mat antraciet
Matt anthracite
Mat zwart
Matt black
Hoogglans wit
High gloss white

MATEN (b x d) MEASUREMENTS (w x d) 60 / 80 / 100 / 120 x 40 cm



40 | GREEPLOOS FINEER EIKEN

40 | HANDLELESS VENEER OAK

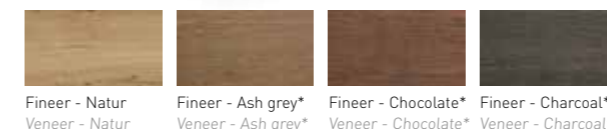
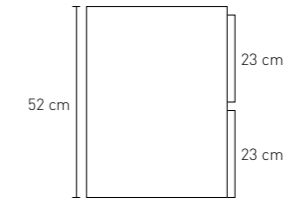

Fineer - Natur
Veneer - Natur
Fineer - Ash grey*
Veneer - Ash grey*
Fineer - Chocolate*
Veneer - Chocolate*
Fineer - Charcoal*
Veneer - Charcoal*

MATEN (b x d) MEASUREMENTS (w x d) 60 / 80 / 100 / 120 x 40 cm

*Coloured by Rubio Monocoat







Ladefronten met horizontale of verticale groeven in massief eiken

De push-to-open onderkasten kunnen nu ook voorzien worden met gegroefde massief eiken ladefronten. Deze 4 mm diepe en brede groeven zijn machinaal gefreesd in het massieve hout en geven het badkamermeubel een superstrak en modern reliëf. De Scandinavische uitstraling van nu! Naar keuze in horizontale of verticale uitvoering.

Drawer fronts with horizontal or vertical grooves in solid oak

The push-to-open cabinets can now also be fitted with grooved solid oak drawer fronts. These 4 mm depth and wide grooves are machined into the solid wood and give the bathroom furniture a super sleek and modern texture. The Scandinavian look of today! Available in a horizontal or vertical version.

ASPEKT 45 cm diep - wastafel links porselein mat wit 120 cm - onderkast 1 lade push to open massief eiken ash grey verticaal gefreesd - spiegel SP23 mat wit 100 x 60 cm

ASPEKT 45 cm depth - washbasin left porcelain matt white 120 cm - cabinet 1 drawer push to open solid oak ash grey vertically milled - mirror SP23 matt white 100 x 60 cm

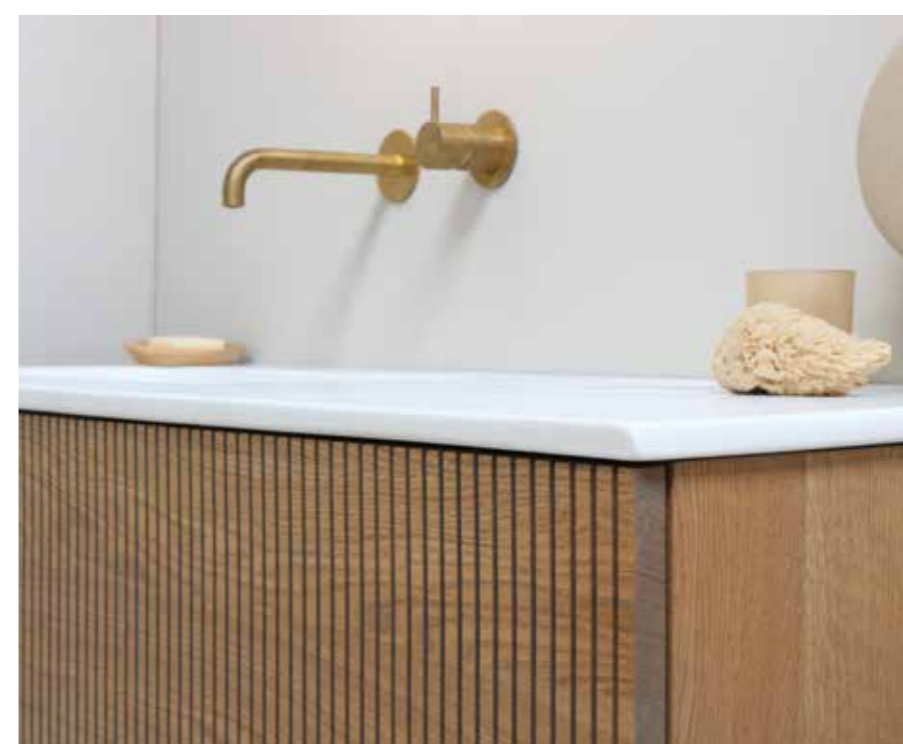

Prachtig dun porselein

Wat voorheen onmogelijk leek in porselein is nu toch wel gelukt. Een wastafel die lekker ruim is, veel aflegruimte heeft en prachtig dun oogt.

Beautiful thin porcelain

What previously seemed impossible in porcelain has now succeeded. A washbasin that is spacious, has a lot of storage space and looks beautifully thin.



ASPEKT 45 cm diep - wastafel dubbel porselein glans wit 160 cm - 2x onderkast 2 laden greeploos gelakt 80 cm mat beton groen - spiegel SP16 40 x 80 cm - 3x hanglamp LED 009 mat wit

ASPEKT 45 cm depth - washbasin double porcelain gloss white 160 cm - 2x cabinet with 2 drawers lacquered handleless 80 cm matt concrete green - mirror SP16 40 x 80 cm - 3x pendant lamp LED 009 matt white





TOPDECK 45 cm diep - opbouwkom Otello 40
 porselein mat poederroze - onderkast 2 laden
 greeploos mat wit 120 cm - afdekplaat mat wit -
 spiegel SP26 - kranen IVY Bond geborsteld mat goud
 - hanglamp LED 009 geborsteld mat goud

TOPDECK 45 cm depth - countertop washbasin
 Otello 40 porcelain matt powder pink - cabinet 2
 drawers lacquered handleless matt white 120 cm -
 cover plate matt white - mirror SP26 - faucets IVY
 Bond brushed matt gold - pendant lamp LED 009
 brushed matt gold

Oh oh Otello!

Met deze opbouwkom kan niet alleen het toilet maar ook elke badkamer worden opgevrolijkt. Pas de ronde kom toe in citroengeel, lichtblauw, poederroze, mat middernachtgrijs, retrogroen of mokkabruin. De Otello kommen zijn mat van kleur en uiteraard in porselein. Deze uitgebreide serie komt nu op totaal 9 kleuren!

Oh oh Otello!

With this countertop washbasin, not only the toilet but also any bathroom can be brightened up. Choose between the colours lemon yellow, light blue, powder pink, matte midnight grey, retro green or mocha brown. The Otello countertop washbasins are matt and ofcourse in porcelain. This series now has a total of 9 colours!

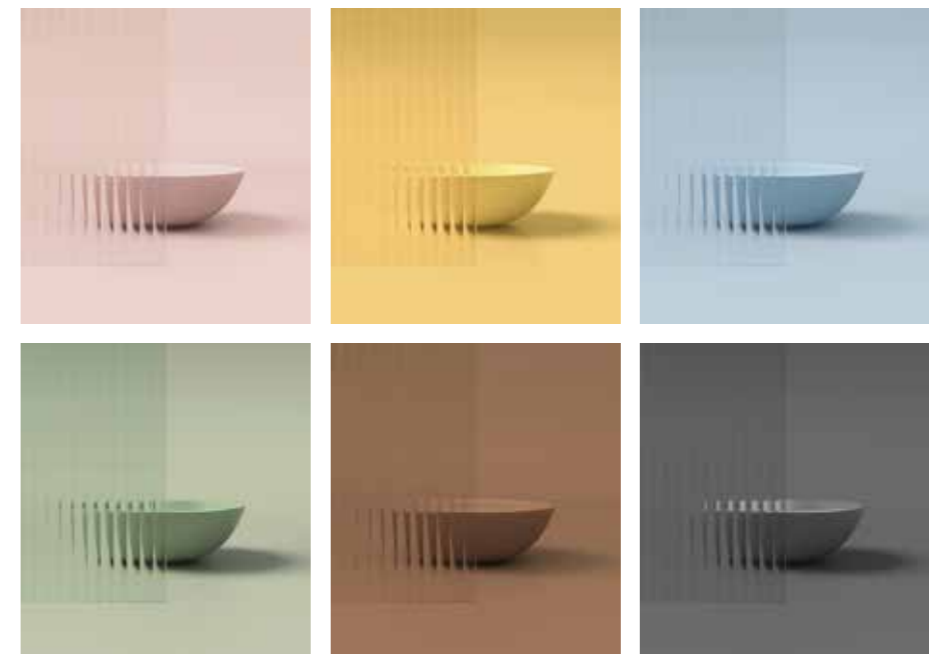



Uitbreiding spiegel collectie

Een echte aanvulling op de spiegel collectie zijn de ovale spiegels verzonken in een gekleurd aluminium kader. Deze spiegels zijn namelijk zowel horizontaal als verticaal te plaatsen en daardoor ook geschikt als passpiegel. Spiegel SP21 heeft het complete pakket; indirecte LED rondom, colour-changing, is dimbaar, heeft een sensorschakelaar én uiteraard spiegelverwarming.

Expansion mirror collection

A real addition to the mirror collection are the oval mirrors recessed in a coloured aluminum frame. These mirrors can be placed both horizontally and vertically and therefore also suitable as a full-length mirror. Spiegel SP21 has the complete package; indirect LED all around, colour-changing, is dimmable, has a sensor switch and of course mirror heating.

TOPDECK 45 cm diep - opbouwkom Otello 40 porselein mat wit - onderkast 1 lade push to open mat beton groen 2x 80 cm - afdekplaat calacatta mat 160 cm - spiegel SP20 mat wit - 2x hanglamp LED 009 mat wit

TOPDECK 45 cm depth - countertop washbasin Otello 40 porcelain matt white - cabinet 1 drawer push to open matt concrete green 2x 80 cm - cover plate calacatta 160 cm - mirror SP20 matt white - 2x pendant lamp LED 009 matt white



PITCH 45 cm diep - wastafel keramiek armani grey 120 cm - onderkast 1 lade push to open massief eiken chocolate verticaal gefreesd - spiegel SP24 mat zwart ø100 cm - hoge kast 1 deur met overstek massief eiken chocolate verticaal gefreesd - uittrekbare wasmand

PITCH 45 cm depth - washbasin ceramic armani grey 120 cm - cabinet 1 drawer push to open solid oak chocolate vertically milled - mirror SP24 matt black ø100 cm - tall cabinet 1 door handleless overhang solid oak chocolate vertically milled - pull-out laundry basket

Nieuwe meubel accessoires

Voor de meeste hoge en halfhoge kasten hebben we nu ook een uittrekbare wasmand beschikbaar.

New furniture accessories

We now also have a pull-out laundry basket available for most tall and semi tall cabinets.





Keramische Slabs

De wastafel Pitch is een hoge wastafel met een schuin aflopende wasbak en een drain gemaakt van hetzelfde sterke keramische materiaal in dezelfde kleur. Keramische slabs zijn aan een opmars bezig in de badkamer en hebben de hardheid van een tegel en de looks van echt natuursteen. De consument kan kiezen uit vier prachtige trendkleuren: wit marmer (Calacatta mat), grijs marmer (Armani grey mat), zwart marmer (Lauren black mat) en wit glans marmer (Statuario glans).

Ceramic Slabs

The sink Pitch is a high sink with a sloping sink and a drain made of the same strong ceramic material in the same colour. Ceramic slabs are on the rise in the bathroom and have the hardness of a tile and the look of real natural stone. The consumer can choose from four beautiful trend colours: white marble (Calacatta matt), gray marble (Armani gray matt), black marble (Lauren black matt) and white gloss marble (Statuario gloss).



PITCH 45 cm diep - wastafel dubbel keramiek statuario glans 140 cm - onderkast 2 laden push to open massief eiken ash grey horizontaal gefreesd - spiegel SP25 ø120 cm

PITCH 45 cm depth - washbasin double ceramic statuario high gloss 140 cm - cabinet 2 drawers push to open solid oak ash grey horizontally milled - mirror SP25 ø120 cm



POST 45 cm diep - wastafel dubbel keramiek lauren black 140 cm - 2x onderkast 2 laden greeploos houten keerlijst asymmetrisch 70 cm zuiver eiken - spiegel SP18 mat zwart 40x80 cm - wandplank 20 cm diep zuiver eiken - 2x hanglamp LED 009 mat zwart

POST 45 cm depth - washbasin double ceramic lauren black 140 cm - 2x cabinet 2 drawers handleless wooden rim asymmetrical 70 cm pure oak - mirror SP18 matt black 40x80 cm - wall shelf depth 20 cm pure oak - 2x pendant lamp LED 009 matt black



FAKTOR 45 cm diep - wastafel links polystone mat wit 160 cm - onderkast 1 lade greeploos 120 cm fineer ash grey - open regaal 40 cm - spiegel SP15 mat zwart ø80 cm - wandlamp LED 008 mat zwart - 2x hanglamp LED 009 mat zwart

FAKTOR 45 cm depth - washbasin left polystone matt white 160 cm - cabinet 1 drawer handleless 120 cm veneer ash grey - open cabinet 40 cm - mirror SP15 matt black ø80 cm - wall lamp LED 008 matt black - 2x pendant lamp LED 009 matt black



Open schap

De interieurs van de badkamermeubelen zijn voorzien van de allerbeste metalen Hettich en Blum ladensystemen en scharnieren. De ladesystemen garanderen een geweldige dempfunctie en een maximale stabiliteit bij het openen en sluiten.

Open cabinet

The bathroom furniture interiors are fitted with the very best metal Hettich and Blum drawer systems and hinges. The drawer systems guarantee a great cushioning function and maximum stability when opening and closing.



TOPDECK 45 cm diep - opbouwkom Enzo
 porselein glans wit - 2x onderkast 1 lade
 greeploos fineer chocolate 70 cm - open regaal
 40 cm - afdekplaat 180 cm - spiegel SP29 mat
 wit 50 x 4 x 100 cm - kranen IVY Bond geborsteld
 mat koper - 2x hanglamp LED 009 mat wit

TOPDECK 45 cm depth - countertop washbasin
 Enzo porcelain gloss white - 2x cabinet 1 drawer
 handleless veneer chocolate 70 cm - open
 cabinet 40 cm - cover plate 180 cm - mirror
 SP29 matt white 50 x 4 x 100 cm - faucets IVY
 Bond brushed matt copper - 2x pendant lamp
 LED 009 matt white

UNLIMITED 45 cm diep - wastafel links
 porselein glans wit 100 cm - onderkast 1 lade
 push to open mat kasjmier grijs - spiegel SPK2
 - Ferro regaal t.b.v. spiegelkast - kranen IVY
 Bond mat zwart

UNLIMITED 45 cm depth - washbasin left
 porcelain gloss white 100 cm - cabinet 1 drawer
 push to open matt cashmere grey - mirror SPK2
 - Ferro frame used for mirror cabinet - faucets
 IVY Bond matt black





SMOOTH 45 cm diep - wastafel dubbel
 polystone mat wit 160 cm - onderkast 1 lade
 push to open zuiver eiken 2x 80 cm - spiegel
 SP32 geborsteld mat goud 50 x 100 cm -
 kranen IVY Bond geborsteld mat goud

SMOOTH 45 cm depth - washbasin double
 polystone matt white 160 cm - cabinet 1
 drawer push to open pure oak 2x 80cm -
 mirror SP32 brushed matt gold 5 x 100 cm -
 faucets IVY Bond brushed matt gold





MOMENTO 45 cm diep - wastafel dubbel quartz zwart
 140 cm - onderkast 1 lade push to open massief
 charcoal - spiegel SP14 - LED line mat zwart

MOMENTO 45 cm depth - washbasin double quartz
 black 140 cm - cabinet 1 drawer push to open solid
 charcoal - mirror SP14 - LED line matt black





MOMENTO 45 cm diep - wastafel dubbel quartz beton
160 cm - 2x Ferro frame 80 cm met stalen inlegplateau
- spiegel SP1

MOMENTO 45 cm depth - washbasin double quartz
concrete 160 cm - 2x Ferro frame 80 cm with steel
insert tray - mirror SP1



KRAFT 45 cm diep - wastafel dubbel
polystone mat wit 160 cm - 2x onderkast
2 laden greeploos gelakt mat wit 80 cm -
spiegel SP6

KRAFT 45 cm depth - washbasin double
polystone matt white 160 cm - 2x cabinet
with 2 drawers handleless lacquered matt
white 80 cm - mirror SP6

SMART XL 140 x 45 cm - opbouwkom Otello
porselein mat wit - 2x onderkast 1 lade greeploos
gelakt mat kasjmier grijs 60 cm - spiegel SP21
geborsteld mat goud 40 x 4 x 80 cm

SMART XL 140 x 45 cm - countertop washbasin
Otello porcelain matt white - 2x cabinet handleless
lacquered matt cashmere grey 60 cm - mirror
SP21 brushed matt gold 40 x 4 x 80 cm





URBAN 45 cm diep - wastafel dubbel porselein
glans wit 120 cm - onderkast 2 laden push to
open koper eiken - spiegel SP4

URBAN 45 cm depth - washbasin double
porcelain gloss white 120 cm - cabinet 2
drawers push to open copper oak - mirror SP4





UNITED 45 cm diep - wastafel links porselein mat wit 120 cm - onderkast 1 lade push to open fineer eiken chocolate verticaal gefreesd - spiegel SP31 geborsteld metal black 40 x 4 x 80 cm - make-up spiegel - kranen IVY Pact geborsteld metal black - 2x hanglamp LED 009 geborsteld metal black

UNITED 45 cm depth - washbasin left porcelain matt white 120 cm - cabinet 1 drawer push to open veneer chocolate vertically milled - mirror SP31 brushed metal black 40 x 4 x 80 cm - make-up mirror - faucets IVY Pact brushed metal black - 2x pendant lamp LED 009 brushed metal black



Luxe combinaties

De Urban Luxe badkamerstijl laat veel zwart zien, maar in combinatie met warmere kleuren en materialen. Een donkere badkamer heeft van zichzelf al een luxe uitstraling. Ga je voor op en top luxe? Combineer de donkere badkamer dan met mat zwarte of gouden accessoires.

Luxurious combinations

The Urban Luxe bathroom style shows a lot of black, but in combination with warmer colours and materials. A dark bathroom has a luxurious appearance in itself. Are you going for ultimate luxury? Then combine the dark bathroom with matte black or golden accessories.

UNITED 45 cm diep - wastafel dubbel porselein mat zwart 160 cm - 2x onderkast 2 laden push to open mat beton groen 80 cm - spiegel SP32 metal black 40 x 4 x 80 cm - kranen IVY Bond geborsteld metal black

UNITED 45 cm depth - washbasin double porcelain matt black 160 cm - 2x cabinet 2 drawers push to open matt concrete green 80 cm - mirror SP32 metal black 40 x 4 x 80 cm - faucets IVY Bond brushed metal black



45 CM DIEP / 45 CM DEPTH

WASTAFELS 45 CM DIEP WASHBASINS 45 CM DEPTH



45 | MOMENTO Polystone | Quartz Pag. 70



45 | SMOOTH Polystone Pag. 70



45 | FAKTOR Polystone Pag. 71



45 | KRAFT Polystone | Quartz Pag. 71



45 | URBAN Porselein Porcelain Pag. 72



45 | UNLIMITED Porselein Porcelain Pag. 72



45 | UNITED Porselein Porcelain Pag. 71



45 | ASPEKT Porselein Porcelain Pag. 71



45 | POST Keramische slab Ceramic slab Pag. 72



45 | PITCH Keramische slab Ceramic slab Pag. 74



45 | TOPDECK Pag. 75

ONDERKASTEN 45 CM DIEP CABINETS 45 CM DEPTH



45 | AFDEKPLAAT 2 CM 45 | COVER PLATE 2 CM Pag. 76



45 | AFDEKPLAAT 3,5 CM 45 | COVER PLATE 3,5 CM Pag. 76



45 | AFDEKPLAAT KERAMISCHE SLAB 1 CM 45 | COVER PLATE CERAMIC SLAB 1 CM Pag. 76



45 | GREEPLOOS HOUTEN KEERLIJST 45 | HANDLELESS WOODEN RIM 1 LADE | 1 DRAWER Pag. 77



45 | GREEPLOOS HOUTEN KEERLIJST 45 | HANDLELESS WOODEN RIM 2 LADEN | 2 DRAWERS Pag. 77



45 | GREEPLOOS HOUTEN KEERLIJST ASYMMETRISCH 45 | HANDLELESS WOODEN RIM ASYMMETRICAL 2 LADEN | 2 DRAWERS Pag. 77



45 | GREEPLOOS GELAKT 45 | HANDLELESS LAQUERED 1 LADE | 1 DRAWER Pag. 77

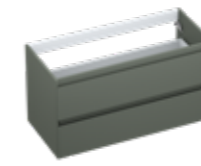

45 | GREEPLOOS GELAKT 45 | HANDLELESS LAQUERED 2 LADEN | 2 DRAWERS Pag. 77



45 | GREEPLOOS GELAKT ASYMMETRISCH 45 | HANDLELESS LAQUERED ASYMMETRICAL 2 LADEN | 2 DRAWERS Pag. 77



45 | GREEPLOOS FINEER 45 | HANDLELESS VENEER 1 LADE | 1 DRAWER Pag. 78



45 | GREEPLOOS FINEER 45 | HANDLELESS VENEER 1 LADE INCL. BINNENLADE 1 DRAWER INCL. INNER Pag. 78



45 | GREEPLOOS FINEER 45 | HANDLELESS VENEER 2 LADEN | 2 DRAWERS Pag. 78



45 | GREEPLOOS FINEER ASYMMETRISCH 45 | HANDLELESS VENEER ASYMMETRICAL 2 LADEN | 2 DRAWERS Pag. 78



45 | PUSH TO OPEN 45 | PUSH TO OPEN 1 LADE | 1 DRAWER Pag. 79



45 | PUSH TO OPEN 45 | PUSH TO OPEN 2 LADEN | 2 DRAWERS Pag. 79



45 | OPEN REGAAL FINEER 45 | OPEN REGAL VENEER Pag. 78



45 | FERRO STALEN FRAME 45 | FERRO STEEL FRAME Pag. 80



45 | SMART XL 45 | SMART XL Pag. 80

45 | MOMENTO



Deze wastafel is verkrijgbaar met of zonder kraangaten.
This washbasin is available with or without tap holes.

MATEN (b x d x h)
MEASUREMENTS (w x d x h)

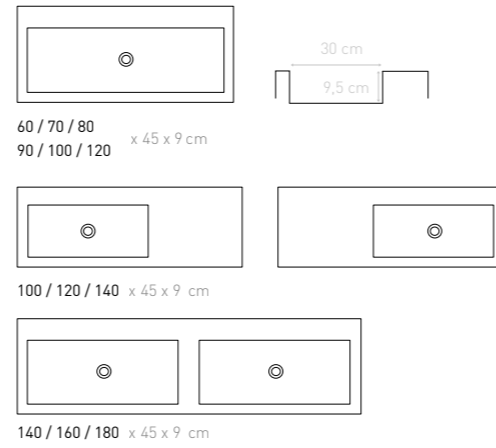

Materiaal Polystone: Glans wit / Mat wit
Material Polystone: Gloss white / Matt white

Materiaal Quartz: Zwart / Beton
Material Quartz: Black / Concrete

45 | FAKTOR



Deze wastafel is verkrijgbaar met of zonder kraangaten.
This washbasin is available with or without tap holes.

MATEN (b x d x h)
MEASUREMENTS (w x d x h)

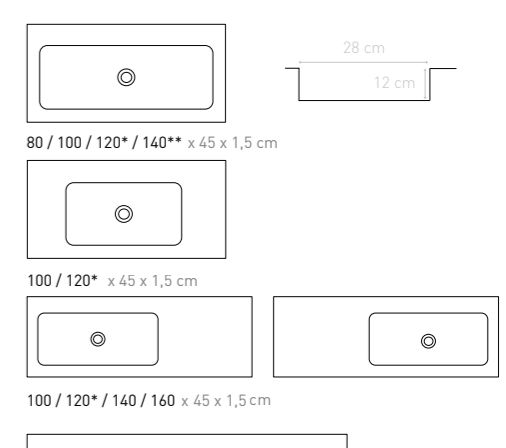

Materiaal Polystone: Glans wit / Mat wit
Material Polystone: Gloss white / Matt white

Materiaal Quartz: Zwart / Beton
Material Quartz: Black / Concrete

* Niet te combineren met 2 onderkasten van 60 cm.
** Uitsluitend te combineren met onderkast: Push-to-Open 140 cm

* Can not be combined with 2 cabinets of 60 cm.
** Can only be combined with cabinet Push-to-Open 140 cm

45 | SMOOTH



Deze wastafel is verkrijgbaar met of zonder kraangaten.
This washbasin is available with or without tap holes.

MATEN (b x d x h)
MEASUREMENTS (w x d x h)

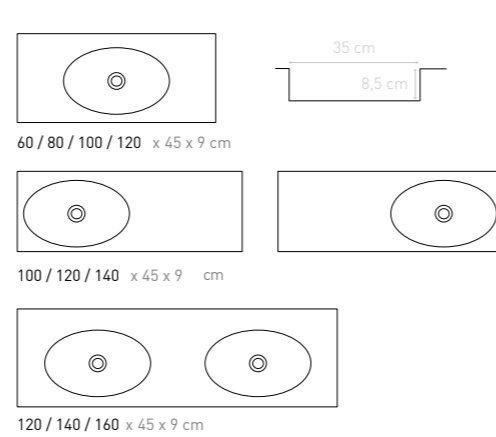

Materiaal Polystone: Glans wit / Mat wit
Material Polystone: Gloss white / Matt white

Materiaal Quartz: Zwart / Beton
Material Quartz: Black / Concrete

45 | KRAFT



Deze wastafel is verkrijgbaar met of zonder kraangaten, incl. clickplug in de kleur van wastafel.
Met bovenstaande wastafel dient u er rekening mee te houden dat het badkamermeubel moet worden voorzien van een 'sifon - bodemuitsparing' in de bovenste lade.

This washbasin is available with or without tap holes, incl. click plug in the colour of the washbasin.
With this washbasin you should take into account that the bathroom cabinet will be specially equipped with a 'siphon - bottom recess' in the top drawer.

MATEN (b x d x h)
MEASUREMENTS (w x d x h)

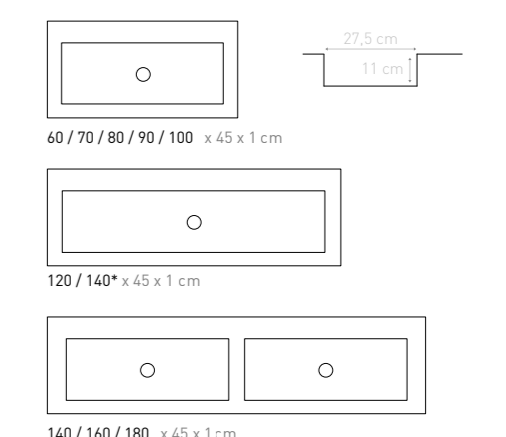

Materiaal Polystone: Glans wit / Mat wit
Material Polystone: Gloss white / Matt white

Materiaal Quartz: Zwart / Beton
Material Quartz: Black / Concrete

* Uitsluitend te combineren met onderkast: Push-to-Open 140 cm
* Can only be combined with cabinet: Push-to-Open 140 cm

45 | URBAN



Deze wastafel is verkrijgbaar met of zonder kraangaten.
This washbasin is available with or without tap holes.



MATEN (b x d x h)
MEASUREMENTS (w x d x h)



70 / 100 x 45 x 8 cm



120 x 45 x 8 cm

Materiaal Porselein: Glans wit
Material Porcelain: Gloss white

45 | UNLIMITED



Deze wastafel is verkrijgbaar met of zonder kraangaten.
De overflowring is verkrijgbaar in de kleuren (optioneel):
- Glans wit
- Mat zwart

This washbasin is available with or without tap holes.
The overflow ring is available in the colours (optional):
- Gloss white
- Matt black



MATEN (b x d x h)
MEASUREMENTS (w x d x h)



60 / 70 / 80 / 90 / 100 / 120 x 45 x 11 cm

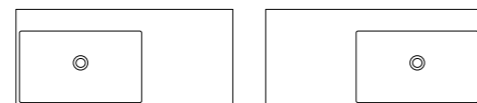

100 / 120 x 45 x 11 cm



120 / 140 / 160 x 45 x 11 cm

Materiaal Porselein: Glans wit
Material Porcelain: Gloss white

45 | UNITED



Deze wastafel is verkrijgbaar met of zonder kraangaten.
incl. clickplug in de kleur van wastafel.

This washbasin is available with or without tap holes.
incl. click plug in the colour of the washbasin.



MATEN (b x d x h)
MEASUREMENTS (w x d x h)

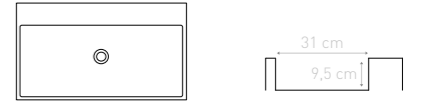

60 / 70 / 80 / 90 / 100 / 120 x 45 x 11 cm



100 / 120 x 45 x 11 cm

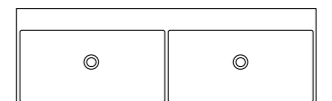

120 / 140 / 160 x 45 x 11 cm

Materiaal Porselein: Glans wit Mat wit
Material Porcelain: Gloss white Matt white
Mat basento Mat zwart
Matt basento Matt black

45 | ASPEKT



Deze wastafel is verkrijgbaar met of zonder kraangaten.

This washbasin is available with or without tap holes.

MATEN (b x d x h)
MEASUREMENTS (w x d x h)

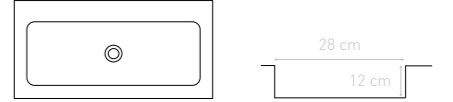

60 / 80 / 100 / 120* x 45 x 1,5 cm

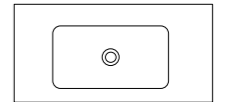

100 / 120* x 45 x 1,5 cm

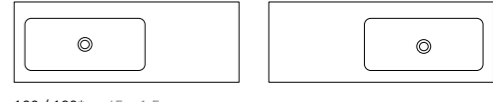

100 / 120* x 45 x 1,5 cm

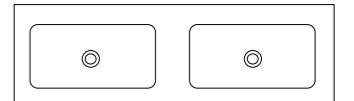

120 / 140 / 160 x 45 x 1,5 cm

Materiaal Porselein: Glans wit Mat wit
Material Porcelain: Gloss white Matt white

* Niet te combineren met 2 onderkasten van 60 cm.
** Uitsluitend te combineren met onderkast: Push-to-Open 140 cm

* Can not be combined with 2 cabinets of 60 cm.
** Can only be combined with cabinet Push-to-Open 140 cm

45 | POST



MATEN (b x d x h)
MEASUREMENTS (w x d x h)

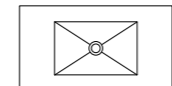

60 / 80 / 100 / 120 x 45 x 1 cm

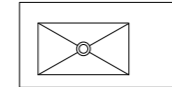

100 / 120 x 45 x 1 cm

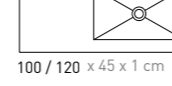

120 / 140 x 45 x 1 cm
160 / 180

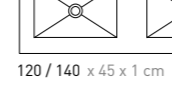

120 / 140 x 45 x 1 cm
160 / 180

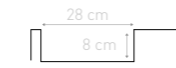

Calacatta mat
Calacatta matt

Armani grey mat
Armani grey matt

Materiaal Keramische slab:
Material Ceramic slab:

Lauren mat black
Lauren matt black

Statuario glans
Statuario gloss

Deze wastafel is verkrijgbaar met of zonder kraangaten.
This washbasin is available with or without tap holes.



45 | PITCH



MATEN (b x d x h)
MEASUREMENTS (w x d x h)

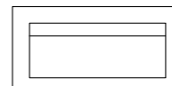

60 / 80 / 100 / 120 x 45 x 9 cm

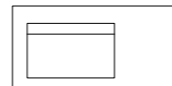

100 / 120* x 45 x 9 cm

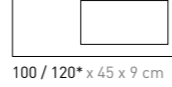

120 / 140 / 160 / 180 x 45 x 9 cm

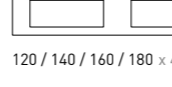

120 / 140 / 160 / 180 x 45 x 9 cm



Calacatta mat
Calacatta matt

Armani grey mat
Armani grey matt

Materiaal Keramische slab:
Material Ceramic slab:

Lauren mat black
Lauren matt black

Statuario glans
Statuario gloss

Deze wastafel is verkrijgbaar met of zonder kraangaten.
This washbasin is available with or without tap holes.



* Niet te combineren met 2 onderkasten van 60 cm.
* Can not be combined with 2 cabinets of 60 cm.

45 | TOPDECK OPBOUW WASTAFELS 45 | TOPDECK COUNTERTOP WASHBASINS



JAZZ LARGE Polystone | Quartz
ø 40 x 12 cm

Materiaal Polystone:
Material Polystone:

Glans wit
Gloss white

Mat wit
Matt white

Materiaal Quartz:
Material Quartz:

Zwart
Black

Beton
Concrete



OTELLO 40 Porselein Porcelain
ø 40 x 14 cm

Glans wit
Gloss white

Mat wit
Matt white

Mat zwart
Matt black

Mat middernachtgrijs
Matt midnight grey

Mat citroengeel
Matt citron yellow

Mat lichtblauw
Matt light blue

Mat poederroze
Matt powder pink

Mat retrogroen
Matt retro green

Mat mokkabruin
Matt mocha brown



ENZO Porselein Porcelain
46 x 32 x 14 cm

Glans wit
Gloss white

Mat wit
Matt white

Mat zwart
Matt black



DISKO Porselein Porcelain
ø 40 x 18 cm

Glans wit
Gloss white

Mat wit
Matt white

Mat basento
Matt basento

Mat zwart
Matt black



UNLIMITED Porselein Porcelain
50 x 38 x 11 cm

Glans wit
Gloss white



TEKNO Porselein Porcelain
ø 42 x 15 cm

Glans wit
Gloss white

Mat wit
Matt white

Mat basento
Matt basento

Mat zwart
Matt black



YALE ROND Porselein Porcelain
ø 40 x 12 cm

Glans wit
Gloss white



YALE VIERKANT Porselein Porcelain
39 x 37 x 12 cm

Glans wit
Gloss white



SOUL ROND Porselein Porcelain
ø 42 x 10 cm

Glans wit
Gloss white



SOUL VIERKANT Porselein Porcelain
55 x 38 x 10 cm

Glans wit
Gloss white

Deze opbouw wastafels worden geleverd met clickplug in de kleur van de opbouw wastafel.

These countertop washbasins comes with a click plug in the colour of the countertop washbasin.

45 | AFDEKPLAAT 2 CM

45 | COVER PLATE 2 CM

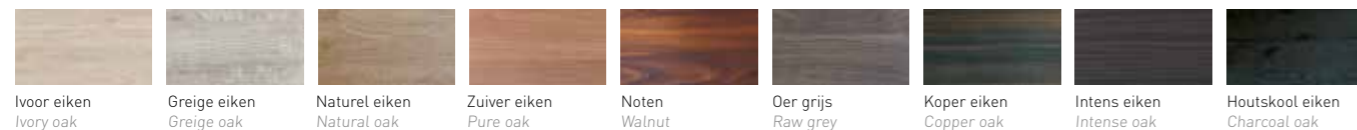

Mat wit / Matt white, Mat kasjmier grijs / Matt cashmere grey, Mat beton groen / Matt concrete green, Mat taupe / Matt taupe, Mat antraciet / Matt anthracite, Mat zwart / Matt black, Hoogglans wit / High gloss white



Fineer Natur / Veneer Natur, Fineer Ash grey* / Veneer Ash grey*, Fineer Chocolate* / Veneer Chocolate*, Fineer Charcoal* / Veneer Charcoal*, Massief Aqua* / Solid oak Aqua*, Massief Ash grey* / Solid oak Ash grey*, Massief Chocolate* / Solid oak Chocolate*, Massief Charcoal* / Solid oak Charcoal*

MATEN (b x d) MEASUREMENTS (w x d) 60 / 70 / 80 / 90 / 100 / 120 / 140 / 160 / 180 x 45 cm *Coloured by Rubio Monocoat

45 | AFDEKPLAAT 3,5 CM

45 | COVER PLATE 3,5 CM

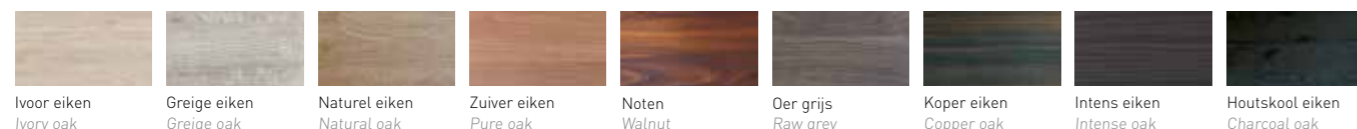

MATEN (b x d) MEASUREMENTS (w x d) 60 / 70 / 80 / 90 / 100 / 120 / 140 / 160 / 180 x 45 cm

45 | AFDEKPLAAT IN KERAMISCHE SLAB 1 CM

45 | COVER PLATE IN CERAMIC SLAB 1 CM



Statuario glans / Statuario gloss, Calacatta mat / Calacatta matt, Armani grey mat / Armani grey matt, Lauren mat black / Lauren matt black

MATEN (b x d) MEASUREMENTS (w x d) 60 / 80 / 100 / 120 / 140 / 160 / 180 x 45 cm

HANDDOEKBEUGEL

TOWEL RAIL



MATEN (b x d x h) MEASUREMENTS (w x d x h) 2 x 44,5 x 12 cm

Materiaal Staal: Material Steel:



Mat wit / Matt white, Mat zwart / Matt black, Geborsteld RVS / Brushed INOX

45 | GREEPLOOS HOUTEN KEERLIJST

45 | HANDLELESS WOODEN RIM

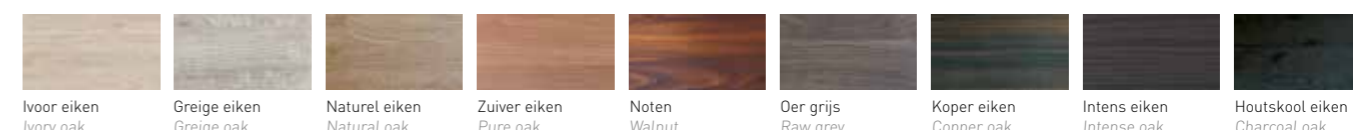
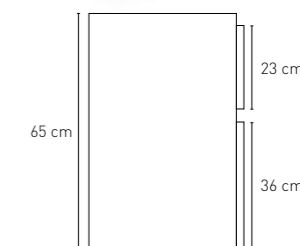
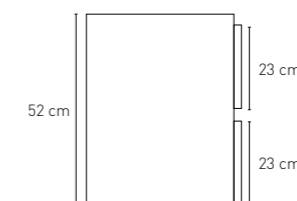

MATEN (b x d) MEASUREMENTS (w x d) 60 / 70 / 80 / 90 / 100 / 120 / 120* / 140* / 160* / 180* x 45 cm

* 2 onderkasten / 2 cabinets

45 | GREEPLOOS GELAKT

45 | HANDLELESS LACQUERED

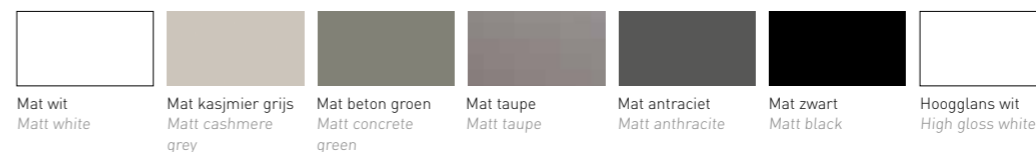
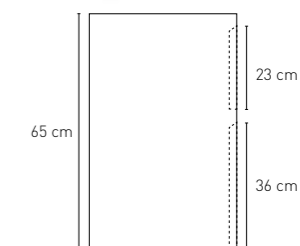
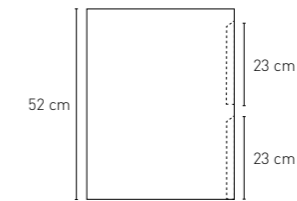
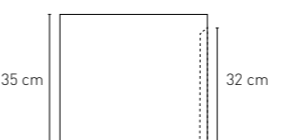

MATEN (b x d) MEASUREMENTS (w x d) 60 / 70 / 80 / 90 / 100 / 120 / 120* / 140* / 160* / 180* x 45 cm

* 2 onderkasten / 2 cabinets

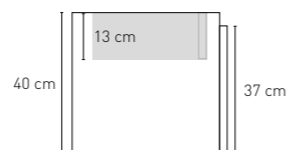
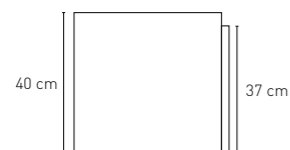

Te combineren wastafels: Momento, Urban, Unlimited, Pitch en Topdeck 45
To combine with: Momento, Urban, Unlimited, Pitch en Topdeck 45

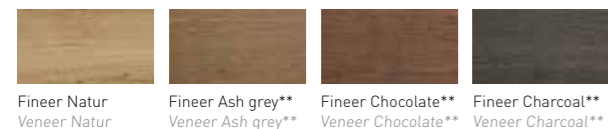
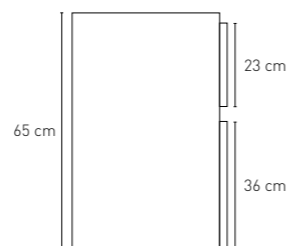
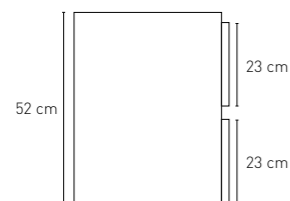

Fineer Natur Veneer Natur
Fineer Ash grey** Veneer Ash grey**
Fineer Chocolate** Veneer Chocolate**
Fineer Charcoal** Veneer Charcoal**

MATEN (b x d) MEASUREMENTS (w x d) 60 / 70 / 80 / 90 / 100 / 120* / 140* / 160* / 180* x 45 cm

* 2 onderkasten / 2 cabinets
**Coloured by Rubio Monocoat



MATEN (b x d x h) MEASUREMENTS (w x d x h)
20 x 45 x 40 cm
40 x 45 x 40 cm
20 x 45 x 52 cm
40 x 45 x 52 cm

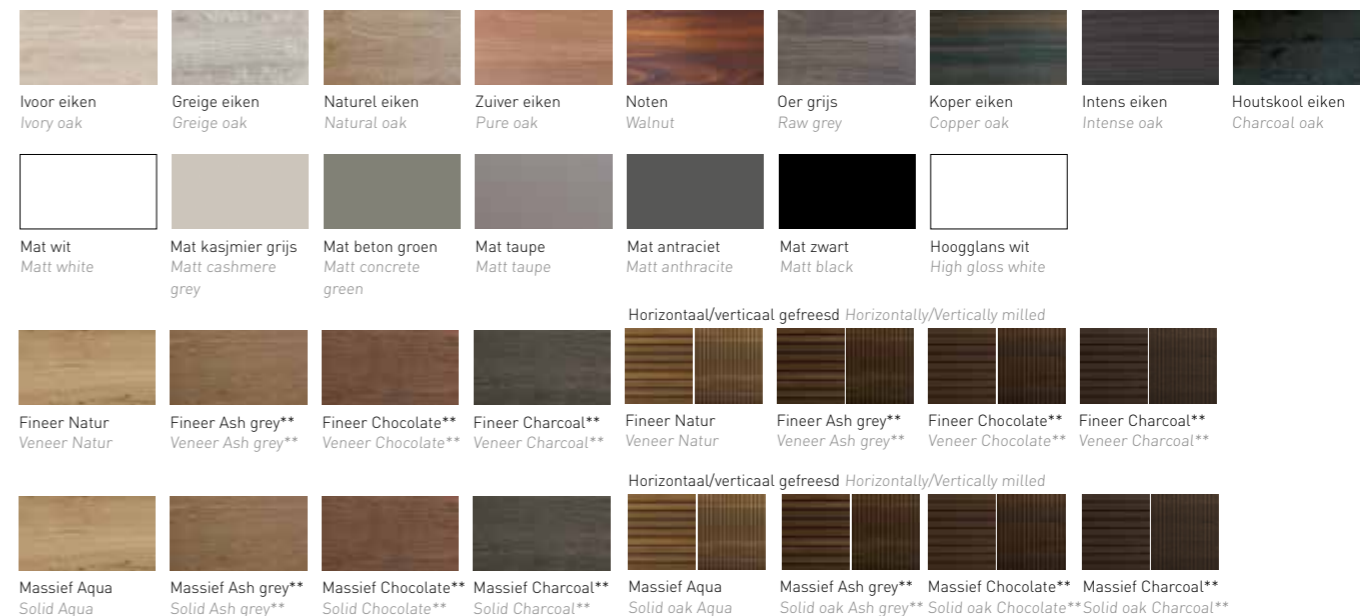
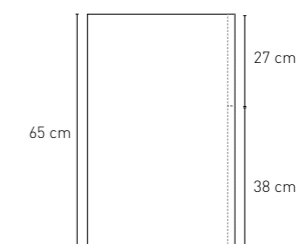
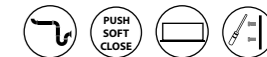

MATEN (b x d) MEASUREMENTS (w x d) 80 / 90 / 100 / 120 / 140 / 160* / 180* x 45 cm

* 2 onderkasten / 2 cabinets
**Coloured by Rubio Monocoat



FERRO FRAME * 2 frames / 2 frames
60 / 70 / 80 / 90 / 100 / 120 / 140 / 160* / 180* x 45 x 27 cm
Inlegplateau optioneel / Steel bottom optional



REGAAL MET VASTE PLATEAU TBV 1 LADE ONDERKAST
FERRO FRAME WITH FIXED BOTTOM USED FOR 1 DRAWER CABINET
40 x 45 x 35 / 38 / 40 cm



REGAAL MET VASTE PLATEAUS TBV 2 LADEN ONDERKAST
FERRO FRAME WITH FIXED BOTTOMS USED FOR 2 DRAWER CABINET
40 x 45 x 52 / 65 cm



REGAAL MET VASTE PLATEAUS TBV SPIEGELKAST
FERRO FRAME WITH FIXED BOTTOMS USED FOR MIRROR CABINET
20 x 14 x 60 / 74 cm



WANDKAST MET VASTE PLATEAUS
FERRO FRAME WITH FIXED BOTTOMS
35 / 70 x 20 x 52 cm



TOPPER MET VASTE PLATEAUS TBV HALF HOGE KAST
TOPPER WITH FIXED BOTTOMS USED FOR SEMI TALL CABINET
35 x 35 x 63 cm



HALF HOGE OPEN KAST MET VASTE PLATEAUS
SEMI TALL OPEN FERRO FRAME WITH FIXED BOTTOMS
35 x 35 x 106 cm



HOGE OPEN KAST MET VASTE PLATEAUS
TALL OPEN FERRO FRAME WITH FIXED BOTTOMS
35 x 35 x 169 cm



100 / 120 x 45 x 20 cm



140 x 45 x 20 cm

LADE-VERDELING

DRAWER DIVIDERS

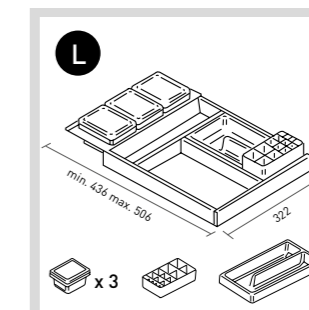
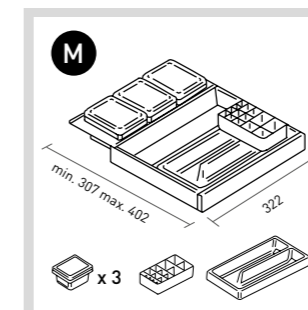
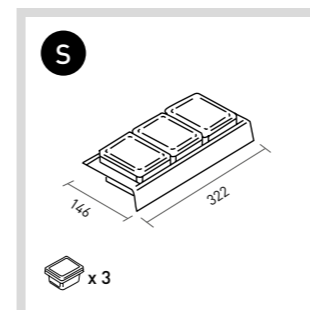

48

Collectie
Collection



48 CM DIEP / 48 CM DEPTH



MATEN (b x d x h)
MEASUREMENTS (w x d x h)

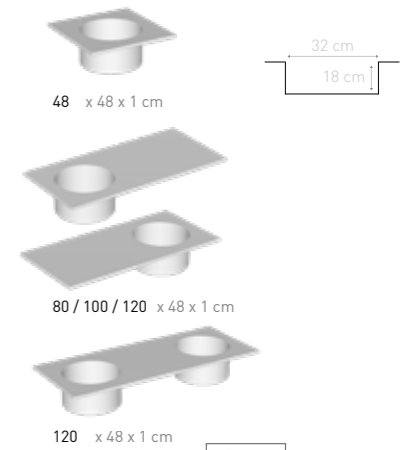

Materiaal Porselein: Glans wit
Material Porcelain: Gloss white

Deze wastafel is verkrijgbaar met of zonder kraangaten.
This washbasin is available with or without tap holes.



MATEN (b x d x h)
MEASUREMENTS (w x d x h)

48 x 48 x 45 cm
80 x 48 x 45 cm
100 x 48 x 45 cm
120 x 48 x 45 cm

Noten: Walnut
Koper eiken: Copper oak
Houtskool eiken: Charcoal oak
Mat zwart: Matt black



MATEN (b x d x h)
MEASUREMENTS (w x d x h)



48 / 80 / 100 / 120 x 48 x 48 cm

Met vaste bodem plaat.
With fixed bottom plate.

Materiaal Staal: Mat zwart
Material Steel: Matt black



LADEVERLICHTING

DRAWER LIGHTING



Kleur:
Colour:



Mat zwart
Matt black

Ladeverlichting bestaande uit LED profiel 30 cm zwart, 12 V - 4000 K met transformator en 5x zwarte kabelgoot van 30 cm

Drawer lighting consisting of LED profile 30 cm black, 12 V - 4000 K with transformer and 5x black cable duct of 30 cm

STOPCONTACT MET USB-POORT

POWER OUTLET WITH USB PORT



Stopcontact met USB-poort voor in de lade, mogelijk bij alle onderkasten. Met spiraalkabel.

Power socket with USB port for in the drawer, possible for all cabinets. With spiral cable.

Kleur:
Colour:



Mat zwart
Matt black

WANDPLANKEN

WALL SHELVES



MATEN (b x d) MEASUREMENTS (w x d)
Vaste maten:
Fixed sizes:
60 / 80 / 90 / 120 / 180 / 275 x 20 x 3,5 cm

Blind te bevestigen
Ook verkrijgbaar in
variabele maten:
30 - 275 cm

Concealed mounting
Also available in
variable sizes:
30 - 275 cm



MATEN (b x d) MEASUREMENTS (w x d)
Vaste maten:
Fixed sizes:
40 / 60 / 80 / 90 / 120 / 180 / 275 x 35 x 3,5 cm

Blind te bevestigen
Ook verkrijgbaar in
variabele maten:
30 - 275 cm

Concealed mounting
Also available in
variable sizes:
30 - 275 cm

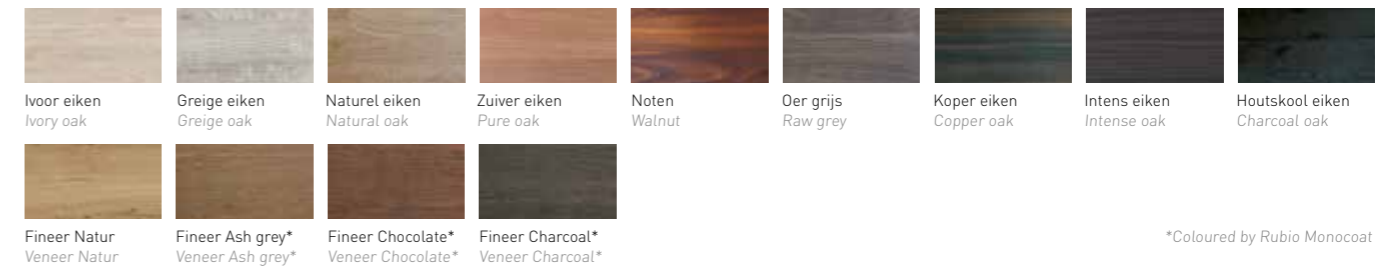

*Coloured by Rubio Monocoat



HOGE EN HALF HOGE KASTEN TALL AND SEMI TALL CABINETS

GREEPLOOS HOUTEN KEERLIJST

HANDLELESS WOODEN RIM

Hoge kast
Tall cabinet

35 x 37 x 169 cm

universeel links/rechts draaiend
2 deuren met houten keerlijst
6 vakken
glazen legplanken

universal left/right rotating
2 doors with wooden rim
6 compartments
glass shelves



Half hoge kast
Semi tall cabinet

35 x 37 x 106 cm

universeel links/rechts draaiend
1 deur met houten keerlijst
3 vakken
glazen legplanken

universal left/right rotating
1 door with wooden rim
3 compartments
glass shelves

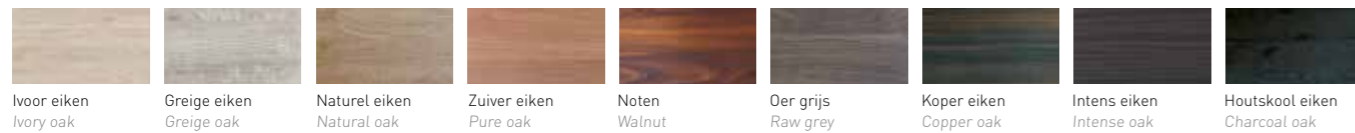

GREEPLOOS GELAKT

HANDLELESS LACQUERED

Hoge kast
Tall cabinet

35 x 35 x 170 cm

universeel links/rechts draaiend
2 deuren met houten keerlijst
6 vakken
glazen legplanken

universal left/right rotating
2 doors with wooden rim
6 compartments
glass shelves



Half hoge kast
Semi tall cabinet

35 x 35 x 106 cm

universeel links/rechts draaiend
1 deur met houten keerlijst
3 vakken
glazen legplanken

universal left/right rotating
1 door with wooden rim
3 compartments
glass shelves

Hoge kast 1-deur (20 cm diep)
Tall cabinet 1-door (20 cm depth)

35 x 20 x 169 cm

universeel links/rechts draaiend
1 deur met spiegel binnenzijde
5 vakken
glazen legplanken

universal left/right rotating
1 door with mirror inside
5 compartments
glass shelves

Hoge kast 1-deur (37 cm diep)
Tall cabinet 1-door (37 cm depth)

35 x 37 x 169 cm

universeel links/rechts draaiend
1 deur met houten keerlijst
5 vakken
glazen legplanken

universal left/right rotating
1 door with wooden rim
5 compartments
glass shelves

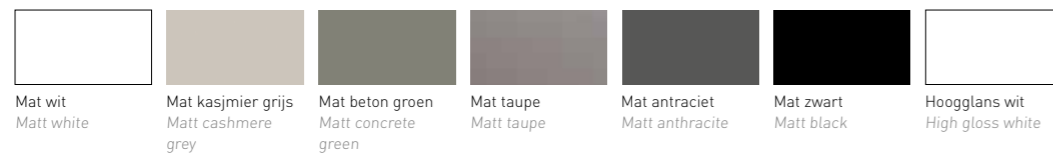

GREEPLOOS FINEER

HANDLELESS VENEER

Hoge kast
Tall cabinet

35 x 35 x 169 cm

universeel links/rechts draaiend
2 deuren met houten keerlijst
6 vakken
glazen legplanken

universal left/right rotating
2 doors with wooden rim
6 compartments
glass shelves



Half hoge kast
Semi tall cabinet

35 x 35 x 106 cm

universeel links/rechts draaiend
1 deur met houten keerlijst
3 vakken
glazen legplanken

universal left/right rotating
1 door with wooden rim
3 compartments
glass shelves

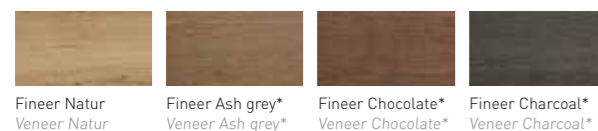

GREEPLOOS MET OVERSTEK

HANDLELESS OVERHANG

Hoge kast
Tall cabinet

36 x 37 x 169 cm

universeel links/rechts draaiend
1 deur greeploos
5 vakken
glazen legplanken

universal left/right rotating
1 door handleless
5 compartments
glass shelves



Blende tbv koppeling dubbele hoge kasten
greeploos met overstek
Blend for linking double tall cabinets
handleless overhang

7 x 169 cm

tussenruimte 5 cm met overstekende deuren
spacing 5 cm with overhanging doors

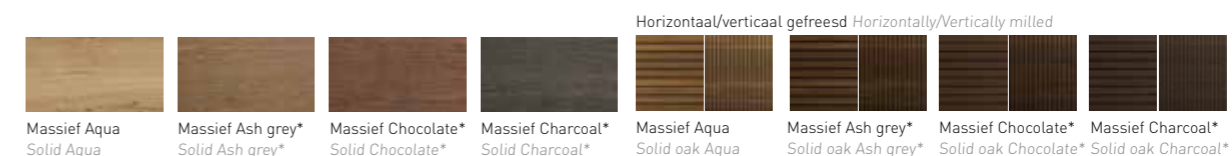
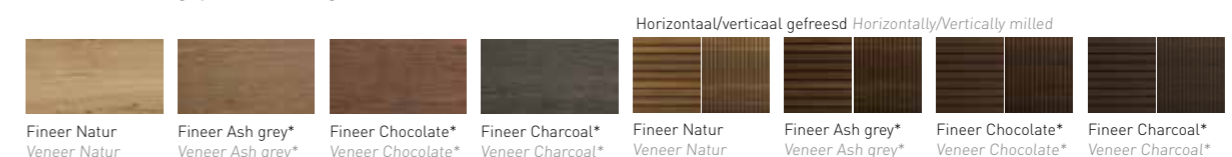
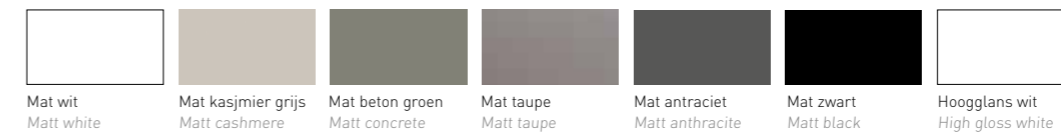
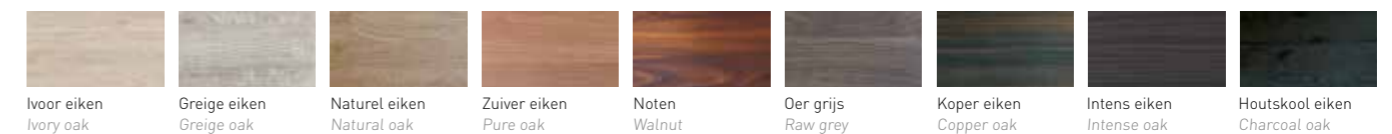

*Coloured by Rubio Monocoat

UITREKBARE WASMAND (OPTIE)

PULL-OUT LAUNDRY BASKET (OPTIONAL)



Uitrekbare wasmand tbv
aangegeven (half) hoge kasten -
ten koste van een planket

Pull-out laundry basket for
indicated (semi) tall cabinets -
at the expense of a shelf

Niet in combinatie mogelijk met
hoge kast greeploos gelakt 20 cm

Not possible in combination
with high cabinet handleless
lacquered 20 cm

Kleur:
Colour:



Antraciet
Anthracite

SPIEGELS IN ALLE VORMEN EN MATEN DIRECT AND INDIRECT LIGHTING

Spiegels met directe verlichting

Vrijwel alle spiegels in kader beschikken over directe verlichting. Hierbij zit het dimbare en colour-changing licht aan de binnenzijde van het verzonken kader. Het licht schijnt hierdoor direct op het gezicht, ideaal voor het aanbrengen van de make-up.

Mirrors with direct lighting

Almost all mirrors with frame have direct lighting. Here, the dimmable and colour-changing light is on the inside of the recessed frame. The light shines directly on the face, ideal for applying make-up.



Spiegels met indirecte verlichting

Een aantal spiegels in de INK collectie is voorzien van indirecte verlichting. De LED lichtbron komt dan van achter de spiegel vandaan en creëert zo het indirecte en sfeervolle strijklicht langs de wand en het badkamermeubel. Ook kan de indirecte verlichting uitgevoerd zijn met een geïntegreerde LED in het spiegelglas. Er is keuze te over in de INK collectie.

Mirrors with indirect lighting

A number of mirrors in the INK collection are equipped with indirect lighting. The LED light source then comes from behind the mirror and thus creates indirect and atmospheric grazing light along the wall and the bathroom furniture. The indirect lighting can also be equipped with an integrated LED in the mirror glass. There is plenty of choice in the INK collection.



Spiegels op alu kader

De spiegels op een alu frame kenmerken zich door het feit dat deze iets van de wand afstaan. Deze collectie spiegels is verkrijgbaar in alle maten die parallel lopen met de badkamermeubel formaten. Deze prachtige spiegels met een duurzame, directe en indirecte ledverlichting zijn verkrijgbaar met dimfunctie, colour-changing, spiegelverwarming en sensorschakeling. Maar natuurlijk ook zonder verlichting.

Mirrors on aluminium frame

The mirrors on an aluminium frame are characterized by the fact that they are slightly apart from the wall. This collection of mirrors is available in all sizes that run parallel to the bathroom furniture sizes. These beautiful mirrors with sustainable, direct and indirect LED lighting are available with dimming and colour-changing function, mirror heating and sensor switch. But of course also available without lighting.



Koud (helder en praktisch)
Cold (clear and practical)



Neutraal
Neutral



Warm (sfeervol)
Warm (atmospheric)

LED kleur aanpassingen

De LED verlichting op de aangegeven spiegels wordt standaard uitgevoerd met een naar eigen keuze in te stellen kleurtemperatuur. Van 2300K (sfeervol) tot 6500K (helder en praktisch). De sensorschakelaar is eveneens standaard voorzien met een geheugen.

LED Colour changing

The LED lighting on the indicated mirrors is standard equipped with a colour changing possibility, to the colour temperature of your choice from 2300K (atmospheric) to 6500K (bright and practical). The sensor switch is standard equipped with a memory.

Spiegels in kader

De spiegels met het aluminium kader sieren inmiddels menig badkamer en toiletruimte. Maar ook zien we deze moderne en praktische spiegels regelmatig terug in de slaapkamer boven de make-up tafel. We hebben deze spiegels in vele kleuren in overeenstemming en passend bij de kleur van de kraan. De fysieke afstand tussen spiegelkader en kraan zorgt namelijk voor een goede kleurervaring. De spiegels in kader zijn verkrijgbaar in tal van vormen: rechthoekig, rond, ovaal, organisch of contourvormig. De spiegelverwarming en duurzame ledverlichting is sensor geschakeld. De direct of indirect verlichtende spiegel is bovendien dimbaar en voorzien van een colour-change functie.

Mirrors in frame

Mirrors with an aluminium frame now adorn many bathrooms and toilets. But we also regularly see these modern and practical mirrors in the bedroom above the make-up table. We have these mirrors in many matching colours that match the colour of the faucets. The physical distance between the mirror frame and the faucet ensures a good colour experience. The mirrors with frame are available in many shapes: rectangular, round, oval, organic or contoured. The mirror heating and sustainable LED lighting are sensor-switched. The directly or indirectly illuminated mirror is also dimmable and equipped with a colour change function.

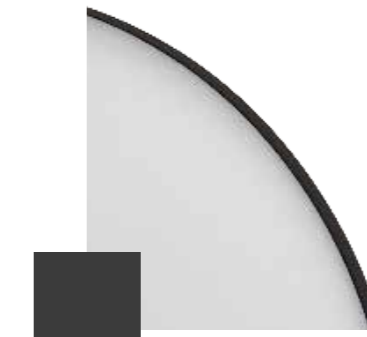

Mat zwart
Matt black

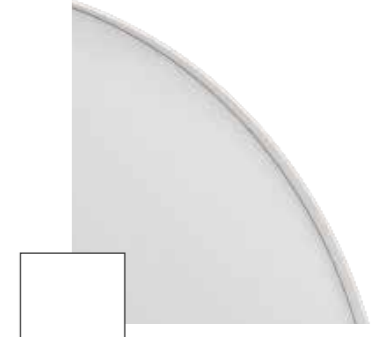

Mat wit
Matt white

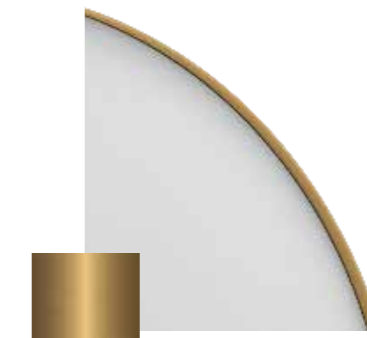

Geborsteld goud
Brushed gold



Geborsteld RVS
Brushed SS

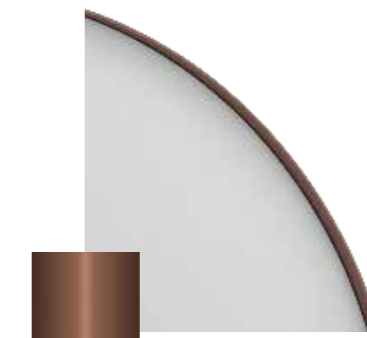

Geborsteld koper
Brushed copper



Geborsteld metal black
Brushed metal black

EXTRA OPTIES

EXTRA OPTIONS



Optionele spiegelverwarming | 220 V
Additional mirror heating | 220 V



Vergrootspiegel
Magnifying mirror



Make-up spiegels incl. drie standen LED
Make-up mirror incl. three settings LED

SPIEGELS IN KADER
MIRRORS IN FRAME

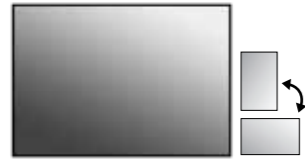

Rechthoek spiegel **SP18**
Rectangle mirror **SP18**

40 / 60 / 70 / 80 / 90 / 100 / 120 / 140 /
160 / 180 x 4 x 80 cm

50 x 4 x 100 cm



Rechthoek spiegel **SP32** met indirecte LED
Rectangle mirror **SP32** with indirect LED

40 / 60 / 70 / 80 / 90 / 100 / 120 / 140 /
160 / 180 x 4 x 80 cm

50 x 4 x 100 cm



Rechthoek spiegel **SP19** met directe LED
Rectangle mirror **SP19** with direct LED

40 / 60 / 70 / 80 / 90 / 100 / 120 / 140 /
160 / 180 x 4 x 80 cm

50 x 4 x 100 cm



Ronde spiegel **SP15**
Round mirror **SP15**

40 / 60 / 80 / 100 / 120 x 4 cm

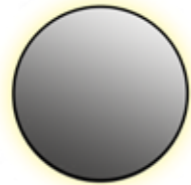

Ronde spiegel **SP17** met indirecte LED
Round mirror **SP17** with indirect LED

40 / 60 / 80 / 100 / 120 x 4 cm



Ronde spiegel **SP24** met directe LED
Round mirror **SP24** with direct LED

40 / 60 / 80 / 100 / 120 x 4 cm



Rechthoek spiegel **SP1**
Rectangle mirror **SP1**

60 / 70 / 80 / 90 / 100 / 120 / 140 / 160 /
180 x 3 x 80 cm



Rechthoek spiegel **SP2** met geïntegreerde LED
Rectangle mirror **SP2** with integrated LED

60 / 70 / 80 / 90 / 100 / 120 / 140 / 160 /
180 x 3 x 80 cm



Rechthoek spiegel **SP3** met indirecte LED
boven **of** onder
Rectangle mirror **SP3** with indirect LED
above or below

60 / 70 / 80 / 90 / 100 / 120 / 140 / 160 /
180 x 4 x 80 cm



Rechthoek spiegel **SP4** met indirecte LED
boven **en** onder
Rectangle mirror **SP4** with indirect LED
above **and** below

60 / 70 / 80 / 90 / 100 / 120 / 140 / 160 /
180 x 4 x 80 cm



Rechthoek spiegel **SP5** met rondom
indirecte LED
Rectangle mirror **SP5** with all around
indirect LED

60 / 70 / 80 / 90 / 100 / 120 / 140 / 160 /
180 x 4 x 80 cm



Rechthoek spiegel **SP6** horizontaal
geïntegreerde LED verlichting en indirecte boven
en onderverlichting
Rectangle mirror **SP6** horizontal integrated LED
lighting and indirect LED above and below

60 / 70 / 80 / 90 / 100 / 120 / 140 / 160 /
180 x 4 x 80 cm

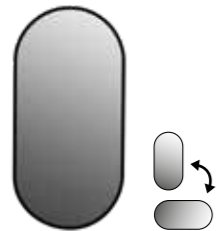

Ovale spiegel **SP20**
Oval mirror **SP20**

30 / 40 x 4 x 80 cm
50 x 4 x 100 cm
60 x 4 x 120 cm
60 x 4 x 180 cm

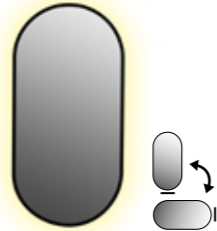

Ovale spiegel **SP21** met indirecte LED
Oval mirror **SP21** with indirect LED

40 x 4 x 80 cm
50 x 4 x 100 cm
60 x 4 x 120 cm

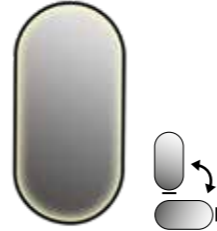

Ovale spiegel **SP28** met directe LED
Oval mirror **SP28** with direct LED

40 x 4 x 80 cm
50 x 4 x 100 cm
60 x 4 x 120 cm



Rechthoek spiegel **SP7** met rondom
indirecte LED en rondom gematteerde rand
Rectangle mirror **SP7** with all around
indirect LED and all around matted border

60 / 70 / 80 / 90 / 100 / 120 / 140 x 3 x 80 cm



Rechthoek spiegel **SP14** in zwart kader incl.
planchet
Rectangle mirror **SP14** with black frame incl.
planchet

48 / 60 / 70 / 80 / 90 / 100 / 120 / 140 / 160 /
180 x 4 x 80 cm



Contour spiegel **SP29**
Contour mirror **SP29**

40 x 4 x 40 cm
60 x 4 x 60 cm
40 / 80 / 120 / 140 / 160 x 4 x 80 cm
50 / 100 x 4 x 100 cm



Contour spiegel **SP30** met indirecte LED
Contour mirror **SP30** with indirect LED

40 x 4 x 40 cm
60 x 4 x 60 cm
40 / 80 / 120 / 140 / 160 x 4 x 80 cm
50 / 100 x 4 x 100 cm



Contour spiegel **SP31** met directe LED
Contour mirror **SP31** with direct LED

40 x 4 x 40 cm
60 x 4 x 60 cm
40 / 80 / 100 / 120 / 140 / 160 x 4 x 80 cm
50 / 100 x 4 x 100 cm



Ronde spiegel **SP12**
Round mirror **SP12**

60 / 70 / 80 / 100 / 120 x 3 cm



Ronde spiegel **SP25** met indirecte LED
Round mirror **SP25** with indirect LED

40 / 60 / 80 / 100 / 120 x 3 cm

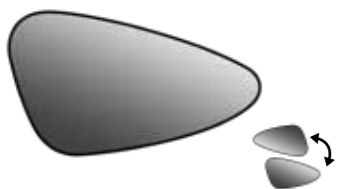

Organische spiegel **SP22**
Organic mirror **SP22**

80 x 4 x 50 cm
100 x 4 x 60 cm
120 x 4 x 70 cm

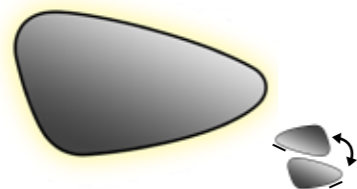

Organische spiegel **SP23** met indirecte LED
Organic mirror **SP23** with indirect LED

80 x 4 x 50 cm
100 x 4 x 60 cm
120 x 4 x 70 cm



Ovale spiegel **SP16**
Oval mirror **SP16**

30 x 4 x 60 cm
40 x 4 x 80 cm

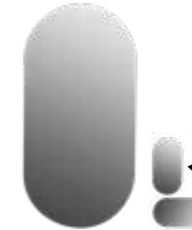

Ovale spiegel **SP26**
Oval mirror **SP26**

40 x 3 x 80 cm
50 x 3 x 100 cm
60 x 3 x 120 cm



Ovale spiegel **SP27** met indirecte LED
Oval mirror **SP27** with indirect LED

40 x 3 x 80 cm
50 x 3 x 100 cm
60 x 3 x 120 cm

SPIEGELKASTEN MIRROR CABINETS

SPK1



Spiegelkast dubbel gespiegeld, incl. verstelbare glazen planketten en schakelaar/stopcontact. Binnenzijde lichtgrijs. Zijpanelen in gewenste kleur.

Mirror cabinet double mirrored, incl. adjustable glass shelves and switch / socket. Interior is light grey. Colour side panels in correspondence with cabinets.

MATEN (b x d x h)
MEASUREMENTS (w x d x h)

- 60 x 14 x 60 cm - 1 deur / 1 door - 1 planket - 1 shelf
- 70 x 14 x 60 cm - 2 deuren / 2 doors - 1 planket - 1 shelf
- 80 x 14 x 60 cm - 2 deuren / 2 doors - 1 planket - 1 shelf
- 90 x 14 x 60 cm - 2 deuren / 2 doors - 1 planket - 1 shelf
- 100 x 14 x 60 cm - 2 deuren / 2 doors - 2 planketten - 2 shelves
- 120 x 14 x 60 cm - 2 deuren / 2 doors - 2 planketten - 2 shelves
- 140 x 14 x 60 cm - 2 deuren / 2 doors - 2 planketten - 2 shelves
- 160 x 14 x 60 cm - 3 deuren / 3 doors - 3 planketten - 3 shelves
- 180 x 14 x 60 cm - 3 deuren / 3 doors - 3 planketten - 3 shelves



SPK2



Spiegelkast dubbel gespiegeld, incl. verstelbare glazen planketten en schakelaar/stopcontact. Binnenzijde lichtgrijs. Zijpanelen in gewenste kleur.

Mirror cabinet double mirrored, incl. adjustable glass shelves and switch / socket. Interior is light grey. Colour side panels in correspondence with cabinets.

MATEN (b x d x h)
MEASUREMENTS (w x d x h)

- 60 x 14 x 74 cm - 1 deur / 1 door - 2 planket - 2 shelves
- 70 x 14 x 74 cm - 2 deuren / 2 doors - 2 planket - 2 shelves
- 80 x 14 x 74 cm - 2 deuren / 2 doors - 2 planket - 2 shelves
- 90 x 14 x 74 cm - 2 deuren / 2 doors - 2 planket - 2 shelves
- 100 x 14 x 74 cm - 2 deuren / 2 doors - 4 planketten - 4 shelves
- 120 x 14 x 74 cm - 2 deuren / 2 doors - 4 planketten - 4 shelves
- 140 x 14 x 74 cm - 3 deuren / 3 doors - 6 planketten - 6 shelves
- 160 x 14 x 74 cm - 3 deuren / 3 doors - 6 planketten - 6 shelves
- 180 x 14 x 74 cm - 3 deuren / 3 doors - 6 planketten - 6 shelves



SPK3



Spiegelkast dubbel gespiegeld, incl. verstelbare glazen planketten en schakelaar/stopcontact. Binnenzijde lichtgrijs. Zijpanelen in gewenste kleur.

+ stalen regaal in zwart of wit

Mirror cabinet double mirrored, incl. adjustable glass shelves and switch / socket. Interior is light grey. Colour side panels in correspondence with cabinets.

+ steel open shelf in black or white

MATEN (b x d x h)
MEASUREMENTS (w x d x h)

- 60 x 14 x 74 cm - 1 deur / 1 door - 1 planket - 1 shelf
- 70 x 14 x 74 cm - 2 deuren / 2 doors - 1 planket - 1 shelf
- 80 x 14 x 74 cm - 2 deuren / 2 doors - 1 planket - 1 shelf
- 90 x 14 x 74 cm - 2 deuren / 2 doors - 1 planket - 1 shelf
- 100 x 14 x 74 cm - 2 deuren / 2 doors - 2 planketten - 2 shelves
- 120 x 14 x 74 cm - 2 deuren / 2 doors - 2 planketten - 2 shelves
- 140 x 14 x 74 cm - 2 deuren / 2 doors - 2 planketten - 2 shelves
- 160 x 14 x 74 cm - 3 deuren / 3 doors - 3 planketten - 3 shelves
- 180 x 14 x 74 cm - 3 deuren / 3 doors - 3 planketten - 3 shelves



SPIEGELKASTEN EXTRA'S

MIRROR CABINETS EXTRAS



Zelfklevende greep tbv spiegelkast
Self-adhesive handle for mirror cabinet



Vergrootspiegel ø11,5 cm
incl. bevestigingstape, vergroot tot 5 keer.
Magnifying mirror ø11,5 cm
incl. mounting tape, enlarged up to 5 times.



Extra glazen planket
Extra glass shelf



Indirecte boven- en/of onderverlichting
Ambient lighting on top and/or bottom



Dubbel stopcontact
Double socket

VERLICHTING LIGHTING



LED 001
5 x 14 x 5 cm
IP44



LED 003
30 x 3 x 4 cm
IP44



LED 007
30 x 4 x 4 cm
IP44



LED 010
30 x 4 x 4 cm
IP44
2000/3000/4000 K

LED 011
30 x 4 x 4 cm
IP44
3000-6000 K



LED balk
60 / 70 / 80 / 90 / 100 / 120 / 140 x 2 x 1,5 cm
IP44
Colour-changing



LED line
48 / 60 / 70 / 80 / 90 / 100 / 120 / 140 / 160 / 180 x 2,5 x 1 cm
IP44
Colour-changing



LED 008
11,5 x 15 x 9 cm
IP44



LED 009
Ø3 x 50 cm
IP20

Fonteinen
Hand washbasins
Collectie / Collection





ENTER fontein mat wit marmer - fontein onderkast greeploos intens eiken - fontein wandkraan en accessoireset 3B mat rosé goud

ENTER hand washbasin white marble - Enter hand washbasin cabinet handleless intense oak - coldwater wall tap and accessory set 3B matt rose gold



ENTER fontein polystone mat wit - fontein frame van staal mat wit - fonteinkraan staand laag model en accessoireset 1A brushed mat goud

ENTER hand washbasin polystone matt white - Enter hand washbasin frame of steel matt white - coldwater tap low and accessory set 1A brushed matt gold

EASY fonteinplateau polystone mat wit ingekort tot 90 cm - **ONE** opbouwkom polystone mat wit - plakspiegel bovenzijde rond afgewerkt - fontein wandkraan en accessoireset 3A brushed mat goud - 2x hanglamp LED 009 mat wit

EASY hand washbasin shelf polystone matt white shortened to 90 cm - **ONE** countertop hand washbasin polystone matt white - round mirror on top - coldwater wall tap and accessory set 3A brushed matt gold - 2x pendant lamp LED 009 matt white



Matrix fontein quartz beton - mat zwart stalen frame - fontein kraan combi set 4A gebogen laag staand model mat zwart

Matrix hand washbasin quartz concrete - matt black steel frame - colwater tap combi set 4A curved raised low model matt black



PLAY 1 fonteinplanchet finer natur - opbouwkom Otello 24 porselein glans wit - plakspiegel van rookglas - fonteinkraan staand hoog model en accessoireset 2A metal black

PLAY 1 hand washbasin shelf veneer natural - countertop hand washbasin Otello 24 porcelain gloss white - adhesive mirror made of smoked glass - coldwater tap tall model and accessory set 2A metal black



PLAY 2 fonteinplanchet finer ash grey - opbouwkom Otello 24 porselein mat wit - fonteinkraan staand hoog model en accessoireset 2A brushed nickel

PLAY 2 hand washbasin shelf veneer ash grey - countertop hand washbasin Otello 24 porcelain matt white - coldwater tap raised and accessory set 2A brushed nickel



PLAY 3 fonteinplanchet finer chocolate - opbouwkom Otello 24 porselein mat zwart

PLAY 3 hand washbasin shelf veneer chocolate - countertop hand washbasin Otello 24 porcelain matt black



VERSUS fontein porselein mat wit - fontein onderkast greeploos zuiver eiken - plakspiegel boven en onderzijde rond afgewerkt - fontein wandkraan en accessoireset 3B brushed mat goud

VERSUS hand washbasin porcelain matt white - hand washbasin cabinet handleless pure oak - adhesive mirror top and bottom - coldwater wall tap and accessory set 3B brushed matt gold

VERSUS fontein polystone mat wit - fontein frame van staal mat wit - fonteinkraan staand laag model en accessoireset 1A mat rosé goud

VERSUS hand washbasin polystone matt white - hand washbasin frame of steel matt white - coldwater tap low and accessory set 1A matt rose gold



CONTRA fontein polystone mat wit - fontein frame mat zwart - fonteinkraan staand laag model en accessoireset 1A mat zwart

CONTRA hand washbasin polystone matt white - hand washbasin frame matt black - coldwater tap low and accessory set 1A matt black

NICE TIME fontein polystone mat wit 120 cm

NICE TIME hand washbasin polystone matt white 120 cm



NICE DAY fontein polystone mat wit 120 cm
- fontein wandkraan en accessoireset 3A mat zwart

NICE DAY hand washbasin polystone matt white
120 cm - coldwater wall tap and accessory set
3A matt black



SKYSCRAPER fontein polystone mat wit -
spiegel op alu frame - fontein wandkraan en
accessoireset 3B mat rosé goud

SKYSCRAPER hand washbasin polystone matt
white - mirror on aluminum frame - coldwater
wall tap and accessory set 3B matt rose gold



HANGAR fontein polystone mat wit met handdoekuitsparing - spiegel SP15 mat wit ø40 cm - fontein wandkraan en accessoireset 3A brushed nickel

HANGAR hand washbasin polystone matt white with towel recess - mirror SP15 matt white ø40 cm - coldwater wall tap and accessory set 3A brushed nickel



SMART frame in staal mat wit - opbouwkom Otello 24 porselein mat wit - onderkast greeploos mat beton groen - spiegel SP15 mat wit ø40 cm - fonteinkraan staand hoog model en accessoireset 2A mat rosé goud

SMART frame in steel matt white - countertop hand washbasin Otello 24 porcelain matt white - cabinet handleless matt concrete green - mirror SP15 matt white ø40 cm - coldwater tap tall and accessory set 2A matt rose gold



VICE fontein polystone mat wit - fonteinkraan staand laag model en accessoireset 1B mat zwart

VICE hand washbasin polystone matt white - coldwater tap low and accessory set 1B matt black

RECESS fontein polystone glans wit - inclusief koudwaterkraan, plug en sifon chrom

RECESS hand washbasin polystone gloss white - including coldwater tap, plug and siphon chrome



TOPDECK XS opbouwkom Jazz XS porselein mat zwart - onderkast push to open fineer chocolate - afdekplaat lauren mat zwart - kraan IVY Bond geborsteld mat koper

TOPDECK XS countertop washbasin Jazz XS porcelain matt black - cabinet push to open veneer chocolate - cover plate lauren matt black - faucet IVY Bond brushed matt copper





BLOCQ mat marmer wit - opbouwkom Otello 24
porselein mat wit - fonteinkraan combi set 2A
staand hoog model mat rosé goud

BLOCQ matt marmer white - countertop hand
washbasin Otello 24 porcelain matt white -
coldwater tap combi set 2A raised model matt
rose gold

JAZZ XS frame in staal mat zwart - inlegplateau naturel eiken - opbouwkom Jazz XS quartz zwart - Linea planchet mat zwart - fontein wandkraan en accessoireset 3A mat zwart

JAZZ XS frame in steel matt black - insert plate natural oak - countertop hand washbasin Jazz XS quartz black - Linea shelf matt black - coldwater wall tap and accessory set 3A matt black



HANDY frame in staal mat zwart - opbouwkom Jazz XS quartz beton - fontein wandkraan en accessoireset 3A mat zwart

HANDY frame in steel matt black - countertop hand washbasin Jazz XS quartz concrete - coldwater wall tap and accessory set 3A matt black



MONO maat M frame in staal mat zwart - opbouwkom Otello 24 porselein mat zwart - Note planchet mat zwart 20 cm breed - plakspiegel 70 cm - fontein wandkraan en accessoireset 3A mat zwart

MONO size M frame in steel matt black - countertop hand washbasin Otello 24 porcelain matt black - Note mirror shelf matt black 20 cm wide - adhesive mirror 70 cm - coldwater wall tap and accessory set 3A matt black

MONO maat S frame in staal mat wit - opbouwkom Jazz XS quartz beton

MONO size S frame in steel matt white - countertop hand washbasin Jazz XS quartz concrete





FORNTEINEN
HAND WASHBASINS



Versus Pag. 120



Contra Pag. 120



Enter Pag. 122



Matrix Pag. 122



Topdeck XS Pag. 124



Blocq Pag. 125



Jazz XS Pag. 126



Smart Pag. 126



Handy Pag. 126



Mono Pag. 128



Vice Pag. 128



Recess Pag. 128



Hangar Pag. 128



Skyscraper Pag. 130



Play Pag. 130



Nice Pag. 130



Easy Pag. 130



Fontein opbouwkommen Pag. 132



Wandplanken Pag. 132



Accessoires Pag. 136



Fonteinkranen Pag. 139

VERSUS



MATEN (b x d x h)
MEASUREMENTS (w x d x h)

Links 36 x 18 x 9 cm
Left

Rechts 36 x 18 x 9 cm
Right

Materiaal Marmer:
Material Marble:

Materiaal Polystone:
Material Polystone:

Glans wit / Gloss white
Mat wit / Matt white

Materiaal Quartz:
Material Quartz:

Zwart / Black
Beton / Concrete

Materiaal Porselein:
Material Porcelain:

Glans wit / Gloss white
Mat wit / Matt white
Mat zwart / Matt black

MATEN (b x d x h)
MEASUREMENTS (w x d x h)

36 x 18 x 9 cm* 36 x 22 x 27 cm

Materiaal Staal:
Material Steel:

Mat wit / Matt white
Mat zwart / Matt black
Geborsteld RVS* / Brushed INOX*

Dit fontein is verkrijgbaar met of zonder kraangat.
This hand washbasin is available with or without tap hole.

CONTRA



MATEN (b x d x h)
MEASUREMENTS (w x d x h)

Links of rechts 40 x 22 x 10 cm
Left or right

Links of rechts 40 x 22 x 10 cm
Left or right

Materiaal Polystone:
Material Polystone:

Glans wit / Gloss white
Mat wit / Matt white

Materiaal Quartz:
Material Quartz:

Zwart / Black
Beton / Concrete

MATEN (b x d x h)
MEASUREMENTS (w x d x h)

40 x 22 x 10 cm 40 x 26 x 29 cm

Materiaal Staal:
Material Steel:

Mat wit / Matt white
Mat zwart / Matt black

Met vaste bodemplaat en handdoekdrager aan voorzijde
With fixed bottom plate and towel rail at the front

Dit fontein is verkrijgbaar met of zonder kraangat.
This hand washbasin is available with or without tap hole.

Fontein Onderkast Greeploos

Hand Washbasin Cabinet Handleless



MATEN (b x d x h)
MEASUREMENTS (w x d x h)

36 x 18 x 27 cm

Universeel links/rechts draaiend met overstek
Universal left/right rotating with overhang

Ivoor eiken / Ivory oak
Greige eiken / Greige oak
Naturel eiken / Natural oak
Zuiver eiken / Pure oak
Noten / Walnut

Oer grijs / Raw grey
Koper eiken / Copper oak
Intens eiken / Intense oak
Houtskool eiken / Charcoal oak

Mat wit / Matt white
Mat kasjmier grijs / Matt cashmere grey
Mat beton groen / Matt concrete green
Mat taupe / Matt taupe

Mat antraciet / Matt anthracite
Mat zwart / Matt black
Hoogglans wit / High gloss white

Fineer Natur / Veneer Natur
Fineer Ash grey* / Veneer Ash grey*
Fineer Chocolate* / Veneer Chocolate*
Fineer Charcoal* / Veneer Charcoal*

*Coloured by Rubio Monocoat

Fontein Onderkast met Push-to-Open Deur

Hand Washbasin Cabinet with Push-to-Open Door



MATEN (b x d x h)
MEASUREMENTS (w x d x h)

40 x 22 x 40

Universeel links/rechts draaiend met overstek
Universal left/right rotating with overhang

Ivoor eiken / Ivory oak
Greige eiken / Greige oak
Naturel eiken / Natural oak
Zuiver eiken / Pure oak
Noten / Walnut

Oer grijs / Raw grey
Koper eiken / Copper oak
Intens eiken / Intense oak
Houtskool eiken / Charcoal oak

Mat wit / Matt white
Mat kasjmier grijs / Matt cashmere grey
Mat beton groen / Matt concrete green
Mat taupe / Matt taupe

Mat antraciet / Matt anthracite
Mat zwart / Matt black
Hoogglans wit / High gloss white

Fineer Natur / Veneer Natur
Fineer Ash grey* / Veneer Ash grey*
Fineer Chocolate* / Veneer Chocolate*
Fineer Charcoal* / Veneer Charcoal*

*Coloured by Rubio Monocoat

ENTER



Dit fontein is verkrijgbaar met of zonder kraangat.
This hand washbasin is available with or without tap hole.

MATEN (b x d x h)
MEASUREMENTS (w x d x h)

Links 40 x 22 x 1 cm
Left

Rechts 40 x 22 x 1 cm
Right

Materiaal Marmer:
Material Marble:

Materiaal Polystone:
Material Polystone:

Glans wit
Gloss white

Mat wit
Matt white

Mat wit
Matt white

Materiaal Quartz:
Material Quartz:

Zwart
Black

Beton
Concrete

Materiaal Porselein:
Material Porcelain:

Glans wit
Gloss white

Mat wit
Matt white

Mat zwart
Matt black

MATEN (b x d x h)
MEASUREMENTS (w x d x h)

40 x 22 x 10 cm

40 x 26 x 29 cm

Materiaal Staal:
Material Steel:

Mat wit
Matt white

Mat zwart
Matt black

Met vaste bodemplaat en handdoekdrager aan voorzijde
With fixed bottom plate and towel rail at the front

MATRIX



Dit fontein is verkrijgbaar met of zonder kraangat.
This hand washbasin is available with or without tap hole.

MATEN (b x d x h)
MEASUREMENTS (w x d x h)

27 x 27 x 10 cm

Materiaal Polystone:
Material Polystone:

Glans wit
Gloss white

Mat wit
Matt white

Materiaal Quartz:
Material Quartz:

Zwart
Black

Beton
Concrete

FORTEIN ONDERKAST MET PUSH-TO-OPEN DEUR

HAND WASHBASIN CABINET WITH PUSH-TO-OPEN DOOR



MATEN (b x d x h)
MEASUREMENTS (w x d x h)

40 x 22 x 40

Universeel links/rechts draaiend met overstek
Universal left/right rotating with overhang

Ivoor eiken
Ivory oak

Greige eiken
Greige oak

Natuur eiken
Natural oak

Zuiver eiken
Pure oak

Noten
Walnut

Oer grijs
Raw grey

Koper eiken
Copper oak

Intens eiken
Intense oak

Houtskool eiken
Charcoal oak

Mat wit
Matt white

Mat kasjmier grijs
Matt cashmere grey

Mat beton groen
Matt concrete green

Mat taupe
Matt taupe

Mat antraciet
Matt anthracite

Mat zwart
Matt black

Hoogglans wit
High gloss white

Fineer Natur
Veneer Natur

Fineer Ash grey*
Veneer Ash grey*

Fineer Chocolate*
Veneer Chocolate*

Fineer Charcoal*
Veneer Charcoal*

*Coloured by Rubio Monocoat



MATEN (b x d x h)
MEASUREMENTS (w x d x h)

27 x 27 x 10 cm

Materiaal Staal:
Material Steel:

Mat zwart
Matt black

TOPDECK XS



MATEN (b x d x h)
MEASUREMENTS (w x d x h)

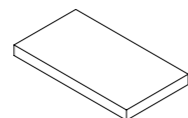

40 x 22 x 1,6/1,2**

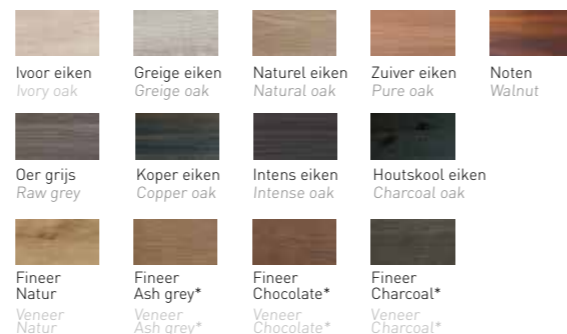

*Coloured by Rubio Monocoat

Materiaal Keramische slab**:
Material Ceramic slab**:



De Topdeck XS kan gecombineerd worden met de volgende opbouwkommen:
- Jazz XS
- Otello 24
- One
[zie pagina 132].

The Topdeck XS can be combined with the following countertop washbasins:
- Jazz XS
- Otello 24
- One
[see page 132].

BLOCQ



MATEN (b x d x h)
MEASUREMENTS (w x d x h)

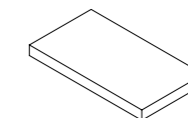

40 x 22 x 6

Materiaal Keramische slab**:
Material Ceramic slab**:



MATEN (b x d x h)
MEASUREMENTS (w x d x h)



40 x 22 x 10 cm



40 x 26 x 29 cm

Met vaste bodemplaat en handdoekdrager aan voorzijde

With fixed bottom plate and towel rail at the front

Materiaal Staal:
Material Steel:



De Blocq kan gecombineerd worden met de volgende opbouwkommen:
- Jazz XS
- Otello 24
[zie pagina 132].

The Blocq can be combined with the following countertop washbasins:
- Jazz XS
- Otello 24
[see page 132].

Fontein Onderkast met Push-to-Open Deur

Hand Washbasin Cabinet with Push-to-Open Door



MATEN (b x d x h)
MEASUREMENTS (w x d x h)



Universeel links/rechts draaiend met overstek
Universal left/right rotating with overhang

40 x 22 x 40

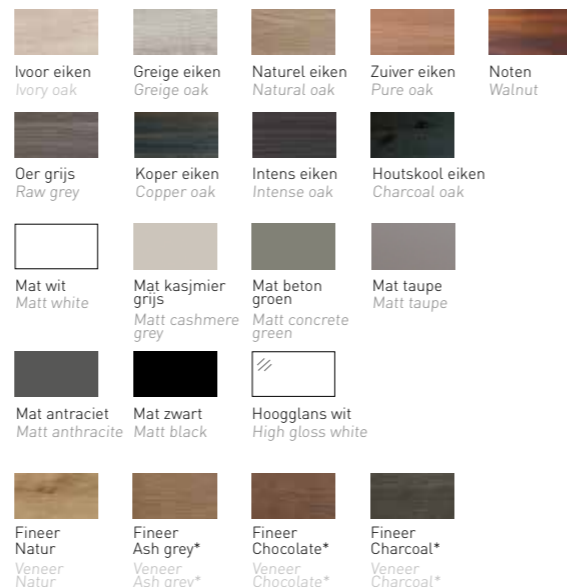

*Coloured by Rubio Monocoat

Fontein Onderkast met Push-to-Open Deur

Hand Washbasin Cabinet with Push-to-Open Door



MATEN (b x d x h)
MEASUREMENTS (w x d x h)



Universeel links/rechts draaiend met overstek
Universal left/right rotating with overhang

40 x 22 x 40

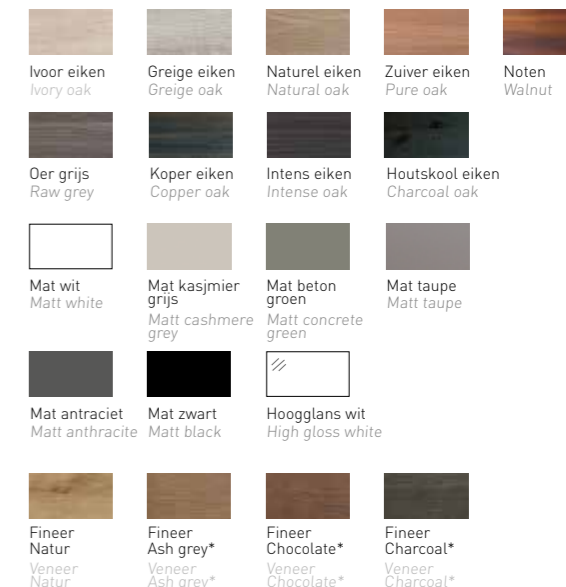

*Coloured by Rubio Monocoat

JAZZ XS FRAME



MATEN (b x d x h)
MEASUREMENTS (w x d x h)
36 x 20 x 5 cm

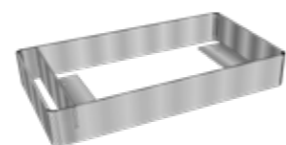

Links
Left



Rechts
Right

Materiaal staal: Glans wit Mat zwart Geborsteld RVS
Material steel: Gloss white Matt black Brushed INOX

Het Jazz XS frame kan gecombineerd worden met de volgende opbouwkommen:
- Jazz XS
- Otello 24
[zie pagina 132].

The Jazz XS frame can be combined with the following countertop washbasins:
- Jazz XS
- Otello 24
[see page 132].

JAZZ XS INLEGPLATEAU

JAZZ XS INLAY PLATEAU

SMART



MATEN (b x d x h)
MEASUREMENTS (w x d x h)
54 x 18 x 20 cm

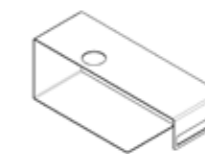

Rechts
Right

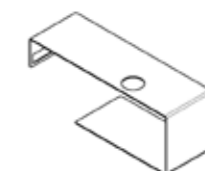

Links
Left

Materiaal Staal: Mat wit Mat zwart
Material Steel: Matt white Matt black

Deze wastafel is verkrijgbaar met of zonder kraangaten.

This washbasin is available with or without tap holes.

Het SMART frame kan gecombineerd worden met alle opbouwkommen [zie pagina 132] en is uit te breiden met de Versus fonteinonderkast [zie pagina 120].

The SMART frame can be combined with all countertop washbasins [see page 132] and can be completed with the Versus hand washbasin cabinet [see page 120].

Dit frame is verkrijgbaar met of zonder kraangat.

This frame is available with or without tap hole.

HANDY



Ivoor eiken Ivory oak	Greige eiken Greige oak	Naturel eiken Natural oak	Zuiver eiken Pure oak	Noten Walnut
Oer grijs Raw grey	Koper eiken Copper oak	Intens eiken Intense oak	Houtskool eiken Charcoal oak	
Mat wit Matt white	Mat kasjmier grijs Matt cashmere grey	Mat beton groen Matt concrete green	Mat taupe Matt taupe	
Mat antraciet Matt anthracite	Mat zwart Matt black	Hoogglans wit High gloss white		
Fineer Natur Veneer Natur	Fineer Ash grey* Veneer Ash grey*	Fineer Chocolate* Veneer Chocolate*	Fineer Charcoal* Veneer Charcoal*	
Massief eiken Aqua* Solid oak Aqua*	Massief eiken Ash grey* Solid oak Ash grey*	Massief eiken Chocolate* Solid oak Chocolate*	Massief eiken Charcoal* Solid oak Charcoal*	

*Coloured by Rubio Monocoat

MATEN (b x d x h)
MEASUREMENTS (w x d x h)



32 x 19 x 2 cm

Materiaal Polystone:
Material Polystone:
 Glans wit
Gloss white Mat wit
Matt white

Materiaal Quartz:
Material Quartz:
 Zwart
Black Beton
Concrete

Materiaal Keramische slab:
Material Ceramic slab:
 Calacatta mat Armani grey mat Lauren mat black Statuario glans



MATEN (b x d x h)
MEASUREMENTS (w x d x h)
21 x 21 x 46,5 cm

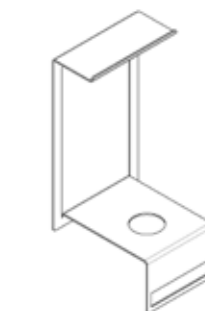

Materiaal Staal: Mat wit Mat zwart
Material Steel: Matt white Matt black

Het HANDY frame kan gecombineerd worden met de volgende opbouwkommen:
- Jazz XS
- Otello 24
- One
[zie pagina 132].

The HANDY frame can be combined with the following countertop washbasins:
- Jazz XS
- Otello 24
- One
[see page 132].

MONO



MATEN (b x d x h)
MEASUREMENTS (w x d x h)

Maat S | Size S 22 x 17 cm

Links / Left Rechts / Right

Maat M | Size M 50 x 17 cm
Met handdoekdrager / with towel holder

Links / Left Rechts / Right

Maat L | Size L 50 x 17 cm
Met handdoekdrager / with towel holder

Links / Left Rechts / Right

Materiaal Staal: Mat wit Mat zwart
Material Steel: Matt white Matt black

Het MONO frame kan gecombineerd worden met de volgende opbouwkommen:

- Jazz XS
- Otello 24
- One

[zie pagina 132]

The MONO frame can be combined with the following countertop washbasins:

- Jazz XS
- Otello 24
- One

[see page 132]

Dit frame is verkrijgbaar met of zonder kraangat.
This frame is available with or without tap hole.

RECESS



MATEN (b x d x h)
MEASUREMENTS (w x d x h)

40 x 21 x 40 cm

Inbouwdiepte = 7 cm
Voorsprong = 11 cm

Inclusief één hendel koudwaterkraan, plug en sifon in **chrom** of **mat zwart**.

Installation depth = 7 cm
Protrusion = 11 cm

One handle coldwater tap, plug and siphon included in **chrome** or **matt black**.

Materiaal Polystone: Glans wit Mat zwart
Material Polystone: Gloss white Matt black

Kleur kraan, plug en sifon: Chrom Mat zwart
Colour tap, plug and siphon: Chrome Matt black

VICE



MATEN (b x d x h)
MEASUREMENTS (w x d x h)

27 x 27 x 9 cm

Materiaal Polystone: Glans wit Mat wit
Material Polystone: Gloss white Matt white

Inclusief verzonken always open plug in de kleur van fontein.
Including always open recessed plug in colour of hand washbasin.

Optioneel VICE frame / Optional VICE frame

27 x 27 x 9 cm

Materiaal Staal: Mat wit Mat zwart
Material Steel: Matt white Matt black

Dit fontein is verkrijgbaar met of zonder kraangat.
This hand washbasin is available with or without tap hole.

HANGAR



MATEN (b x d x h)
MEASUREMENTS (w x d x h)

40 x 20 x 30 cm

Rechts
Right

Links
Left

Materiaal Polystone: Glans wit Mat wit
Material Polystone: Gloss white Matt white

Dit fontein is verkrijgbaar met of zonder kraangat.
This hand washbasin is available with or without tap hole.

SKYSCRAPER



MATEN (b x d x h)
MEASUREMENTS (w x d x h)

20 x 20 x 27 cm

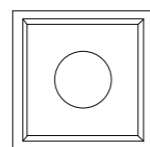

Inclusief verzonken always open plug in de kleur van fontein.
Including always open recessed plug in colour of hand washbasin.

Materiaal Polystone: Glans wit Mat wit
Material Polystone: Gloss white Matt white

Dit fontein is alleen verkrijgbaar zonder kraangat.
This hand washbasin is only available without tap hole.

PLAY



MATEN (b x d x h)
MEASUREMENTS (w x d x h)

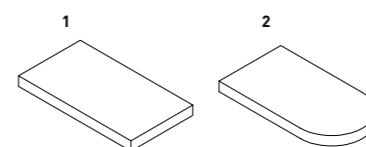

40 x 22 x 3,2 cm

40 x 22 x 3,2 cm

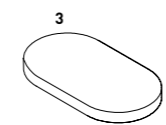

40 x 22 x 3,2 cm

Inclusief blinde bevestiging.
Including concealed shelf support.

Fineer Natur Veneer Natur
Fineer Ash grey* Veneer Ash grey*
Fineer Chocolate* Veneer Chocolate*
Fineer Charcoal* Veneer Charcoal*

*Coloured by Rubio Monocoat

Het PLAY planchet kan gecombineerd worden met alle opbouwkommen [zie pagina 132].

The PLAY shelf can be combined with all countertop washbasins [see page 132].

Uitsparing voor kraan en sifon kan gemaakt worden m.b.v. een komboor voor hout.

Holes for tap and plug can be made with a hole saw for cutting wood.

NICE & EASY



Nice (met geïntegreerde waskom / with integrated washbasin)



Easy (met opbouwkom / with countertop washbasin)

Nice Day - Met ovale geïntegreerde waskom
with oval integrated washbasin

Nice Time - Met rechthoekige geïntegreerde waskom
with rectangle integrated washbasin

Het EASY fonteinplateau kan gecombineerd worden met de volgende opbouwkommen:
- One (ovaal)
- Break (rechthoekig)
- Jazz XS (rond)

The EASY countertop plateau can be combined with the following countertop washbasins:
- One (oval)
- Break (rectangular)
- Jazz XS (round)

[zie pagina 132]

[see page 132]

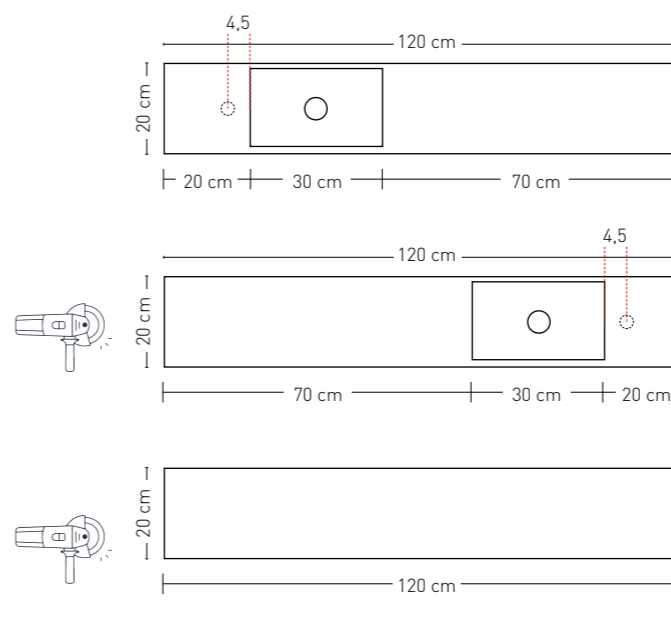

NICE links - aan beide zijden in te korten
Sideskirt aan linkerzijde

NICE left - can be shortened on both sides
Sideskirt on left side

NICE right - aan beide zijden in te korten
Sideskirt aan rechterzijde

NICE right - can be shortened on both sides
Sideskirt on right side

EASY - aan beide zijden in te korten
Sideskirts aan voorkant en zijkant

EASY - to be shortened at any place
With front and side skirts

Dit fontein is verkrijgbaar met of zonder kraangat.
Uitsparingen zijn te maken met een komboor voor steen.

This countertop washbasin is available with or without tap hole.
Savings can be made with a hole saw for cutting stone.

Materiaal Polystone: Glans wit Mat wit
Material Polystone: Gloss white Matt white

In te korten in het werk m.b.v. haakse slijper voor steen
Can be shortened on site with an angle grinder for stone

Fontein opbouwkommen





COUNTERTOP HAND WASHBASINS



JAZZ XS Polystone | Quartz

MATEN (b x d x h)
MEASUREMENTS (w x d x h)

ø 20 x 11 cm

		
Materiaal Polystone:	Glans wit	Mat wit
Material Polystone:	Gloss white	Matt white
		
Materiaal Quartz:	Zwart	Beton
Material Quartz:	Black	Concrete



OTELLO 24 Porselein Porcelain

MATEN (b x d x h)
MEASUREMENTS (w x d x h)

Ø 24 x 12 cm

			
Glans wit	Mat wit	Mat zwart	
Gloss white	Matt white	Matt black	
			
Mat middernachtgrijs	Mat citroengeel	Mat lichtblauw	
Matt midnight grey	Matt citron yellow	Matt light blue	
			
Mat poederroze	Mat retrogroen	Mat mokkabruin	
Matt powder pink	Matt retro green	Matt mocha brown	



ONE Polystone

MATEN (b x d x h)
MEASUREMENTS (w x d x h)

33 x 19 x 10 cm



	
Glans wit	Mat wit
Gloss white	Matt white



BREAK Polystone

MATEN (b x d x h)
MEASUREMENTS (w x d x h)

27 x 18 x 10 cm

	
Glans wit	Mat wit
Gloss white	Matt white

20 | WANDPLANK 3,5 CM 20 | WALL SHELVES 3.5 CM

Te combineren met fontein opbouwkommen - blind te bevestigen
Beschikbaar in alle decor- en fineerkleuren
Can be combined with countertop hand washbasins - concealed mounting
Available in all decor and veneer colours.

MATEN (b x d x h)
MEASUREMENTS (w x d x h)

Vaste maten / Fixed sizes:

60 / 80 / 90 / 120 / 180 / 275 x 20 x 3.5 cm



Ook verkrijgbaar in variabele maten: 30 - 275 cm
Also available in variable sizes: 30 - 275 cm





Fonteinspiegels en Fonteinplanchetten

MIRRORS AND SHELVES

Fontein Plakspiegel

ADHESIVE MIRROR



MATEN (b x d x h)
MEASUREMENTS (w x d x h)

10 x 0,4 x 70 cm
10 x 0,4 x 100 cm

incl. bevestigingstape
incl. mounting tape

Fontein Plakspiegel Rookglas

ADHESIVE MIRROR SMOKED GLASS



MATEN (b x d x h)
MEASUREMENTS (W X D X H)

10 x 0,4 x 70 cm

incl. bevestigingstape
incl. mounting tape

Plakspiegel Rond

ADHESIVE MIRROR ROUND



MATEN
MEASUREMENTS

Ø32 x 0,4 cm

incl. bevestigingstape
incl. mounting tape

Plakspiegel Boven en Onder Rond

ADHESIVE MIRROR ROUND
TOP AND BOTTOM



MATEN (b x d x h)
MEASUREMENTS (w x d x h)

20 x 0,4 x 70 cm

incl. bevestigingstape
incl. mounting tape

Plakspiegel Ovaal

ADHESIVE MIRROR OVAL



MATEN (b x d x h)
MEASUREMENTS (w x d x h)

20 x 0,4 x 70 cm

incl. bevestigingstape
incl. mounting tape

Plakspiegel Bovenzijde Rond

ADHESIVE MIRROR TOP ROUND



MATEN (b x d x h)
MEASUREMENTS (w x d x h)

20 x 0,4 x 70 cm

incl. bevestigingstape
incl. mounting tape

Fonteinspiegel op Houten Plaat

MIRROR ON WOODEN PLATE



MATEN (b x d x h)
MEASUREMENTS (w x d x h)

20 x 2 x 70 cm
36 x 2 x 70 cm

Fonteinspiegel op Alu Frame

MIRROR ON ALU FRAME



MATEN (b x d x h)
MEASUREMENTS (w x d x h)

20 x 3 x 90 cm

UFO Planchet Frame

UFO SHELF FRAME



MATEN (b x d x h)
MEASUREMENTS (w x d x h)

48 x 15 x 15 cm
80 x 15 x 15 cm
100 x 15 x 15 cm
120 x 15 x 15 cm

Frame is mat zwart met vaste bodemplaat
en verplaatsbare spiegel rond Ø 32 cm

Frame in matt black with fixed bottom
plate and movable round mirror Ø 32 cm

ANGLO HOEKPLANCHET

ANGLO CORNER SHELF



MATEN (b x d x h)
MEASUREMENTS (w x d x h)

20 x 20 x 72

Mat zwart
Matt black

LINEA PLANCHET

LINEA SHELF

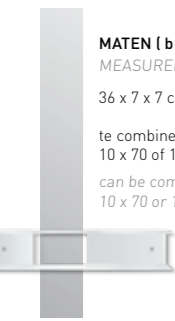

MATEN (b x d x h)
MEASUREMENTS (w x d x h)

36 x 7 x 7 cm

te combineren met fontein plakspiegel
10 x 70 of 10 x 100 cm
can be combined with adhesive mirror
10 x 70 or 10 x 100 cm

Glans wit Mat zwart Geborsteld RVS
Gloss white Matt black Brushed INOX

NOTE PLANCHET

NOTE MIRROR SHELF



MATEN (b x h)
MEASUREMENTS (w x h)

36 x 72 cm

van staal | incl. 4 magneten
spiegel naar eigen inzicht te plaatsen
made of steel | 4 magnets included
mirror is placeable at your own discretion

Glans wit Mat zwart Geborsteld RVS
Gloss white Matt black Brushed INOX

NOTE PLANCHET

NOTE MIRROR SHELF



MATEN (b x h)
MEASUREMENTS (w x h)

20 x 72 cm

van staal | incl. 4 magneten
spiegel naar eigen inzicht te plaatsen
made of steel | 4 magnets included
mirror is placeable at your own discretion

Glans wit Mat zwart Geborsteld RVS
Gloss white Matt black Brushed INOX



Linea 36 x 7 cm - mat zwart / matt black



Note 20 x 72 cm - geborsteld RVS / brushed INOX



Note 36 x 72 cm - mat zwart / matt black

SP14 FONTEINSPIEGEL RECHTHOEK

SP14 MIRROR RECTANGLE



MATEN (b x d x h)
MEASUREMENTS (w x d x h)

48 x 10 x 80 cm
60 x 10 x 80 cm

inclusief planchet mat zwart
including shelf in matt black

SP17 FONTEINSPIEGEL ROND IN KADER

SP17 ROUND MIRROR SET BACK IN FRAME



MATEN
MEASUREMENTS

40 x 4 cm
60 x 4 cm

verzonken in kader met
indirect LED verlichting
recessed in frame with
indirect LED lighting

SP15 FONTEINSPIEGEL ROND IN KADER

SP15 ROUND MIRROR SET BACK IN FRAME



MATEN
MEASUREMENTS

40 x 4 cm
60 x 4 cm

SP18 FONTEINSPIEGEL IN KADER

SP18 MIRROR SET BACK IN FRAME



MATEN (b x d x h)
MEASUREMENTS (w x d x h)

40 x 4 x 80
50 x 4 x 100
60 x 4 x 80

kan zowel horizontaal als
verticaal opgehangen worden
can be placed both
horizontally and vertically

SP16 FONTEINSPIEGEL OVAAL OP ALU FRAME

SP16 MIRROR OVAL ON ALU FRAME



MATEN (b x d x h)
MEASUREMENTS (w x d x h)

30 x 3 x 60 cm
40 x 3 x 80 cm

SP19 FONTEINSPIEGEL IN KADER

SP19 MIRROR SET BACK IN FRAME



MATEN (b x d x h)
MEASUREMENTS (w x d x h)

40 x 4 x 80

- met directe LED verlichting
- kan zowel horizontaal als verticaal opgehangen worden
- with direct LED lighting
- can be placed both horizontally and vertically

SP20 OVALE FONTEINSPIEGEL IN KADER

SP20 OVAL MIRROR SET BACK IN FRAME



MATEN (b x d x h)
MEASUREMENTS (w x d x h)

30 x 4 x 80
40 x 4 x 80

kan zowel horizontaal als
verticaal opgehangen worden
can be placed both
horizontally and vertically

SP21 OVALE FONTEINSPIEGEL IN KADER

SP21 OVAL MIRROR SET BACK IN FRAME



MATEN (b x d x h)
MEASUREMENTS (w x d x h)

40 x 4 x 80

- met indirecte LED verlichting
- kan zowel horizontaal als verticaal opgehangen worden
- with indirect LED lighting
- can be placed both horizontally and vertically

SP24 FONTEINSPIEGEL ROND IN KADER

SP24 ROUND MIRROR SET BACK IN FRAME



MATEN
MEASUREMENTS

40 x 4 cm
60 x 4 cm

verzonken in kader met
direct LED verlichting
recessed in frame with
direct LED lighting

SP25 FONTEINSPIEGEL ROND OP ALU FRAME

SP25 ROUND MIRROR ON ALU FRAME



MATEN
MEASUREMENTS

40 x 3 cm
60 x 3 cm

met indirecte LED verlichting
with indirect LED lighting

SP26 FONTEINSPIEGEL OVAAL OP ALU FRAME

SP26 ROUND MIRROR OVAL ON ALU FRAME



MATEN
MEASUREMENTS

40 x 3 x 80
50 x 3 x 100
60 x 3 x 120

kan zowel horizontaal als
verticaal opgehangen worden
can be placed both
horizontally and vertically

SP27 FONTEINSPIEGEL OVAAL OP ALU FRAME

SP27 ROUND MIRROR OVAL ON ALU FRAME



MATEN
MEASUREMENTS

40 x 3 x 80
50 x 3 x 100
60 x 3 x 120

- met indirecte LED verlichting
- kan zowel horizontaal als verticaal opgehangen worden
- with indirect LED lighting
- can be placed both horizontally and vertically

KLEUR KADER:
COLOURS FRAME

Mat zwart / Matt black
 Mat wit / Matt white
 Geborsteld goud / Brushed gold
 Geborsteld koper / Brushed copper
 Geborsteld RVS / Brushed SS
 Geborsteld metal black / Brushed metal black



FORTEINKRANEN EN ACCESSOIRES

COLDWATER FAUCETS AND ACCESSORIES



FORTEINKRAAN STAAND LAAG MODEL
COLDWATER TAP LOW MODEL



FORTEINKRAAN STAAND HOOG MODEL
COLDWATER TAP RAISED MODEL



FORTEINKRAAN GEBOGEN STAAND LAAG MODEL
COLDWATER TAP CURVED RAISED LOW MODEL



FORTEINKRAAN GEBOGEN STAAND HOOG MODEL
COLDWATER TAP CURVED RAISED HIGH MODEL



WAND FORTEINKRAAN (INKORTBAAR)
COLDWATER WALL TAP
(CAN BE SHORTENED)



HOEKSTOPKRAAN
ANGLE VALVE TAP



DESIGN SIFON (LAAG MODEL)
DESIGN SIPHON (LOW MODEL)



AFVOERPLUGGEN
PLUGS always open | stop & go

KLEUR KRANEN EN ACCESSOIRES:

COLOUR TAPS AND ACCESSORIES:

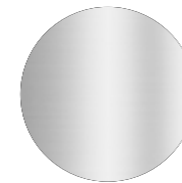

Chroom
Chrome

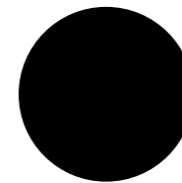

Mat zwart
Matt black

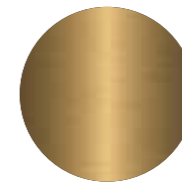

Brushed mat goud
Brushed matt gold

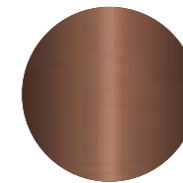

Mat rosé goud
Matt rose gold

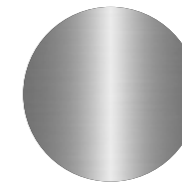

Brushed nickel
Brushed nickel

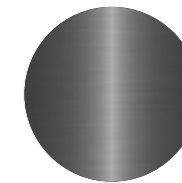

Metal black
Metal black

Over Sanibell.

Sanibell is de klantgerichte partner voor de gespecialiseerde sanitairwinkels maar ook voor (binnenhuis) architecten, interieurontwerpers en projectontwikkelaars. Samen komen we altijd tot de beste oplossing voor de klant. Met prachtige en actuele badkamermeubelen en wastafels uit de uitgebreide en toonaangevende INK collecties. De meubelcollecties van Sanibell worden zorgvuldig geproduceerd vanuit strenge Nederlandse normen en kwaliteitseisen en zijn altijd uit voorraad leverbaar.

Ook met maatwerkoplossingen van het zustermerk Bliss® vervullen wij de meest creatieve meubelwensen van de klanten. Vraag gerust naar de mogelijkheden.

Sanibell ontwerpt, ontwikkelt en fabriceert badkamermeubelen, wastafels en fonteinen in porselein, polystone, quartz, solid surface, keramiek (slabs) en marmer. Naast deze badkamermeubelen maken ook de uitgebreide collecties spiegels, spiegelkasten en verlichting een onlosmakelijk deel uit van deze stijlvolle collecties. Deze collecties blinken uit in design, kwaliteit en functionaliteit.

Sinds 2024 maakt het kranenmerk IVY® deel uit van het productassortiment van Sanibell. Deze volledig in eigen huis ontwikkelde badkamerkranen onderscheiden zich met kwaliteit, duurzaamheid, installatiegemak, design en betaalbaarheid. Vanzelfsprekend heeft Sanibell ook deze IVY badkamerkranen op voorraad. In alle kleuren!



GESCHIEDENIS

Sanibell is opgericht in 1978 en had haar eerste magazijn in Rotterdam op wat we nu de kop van Zuid noemen, vlakbij het hoofdkantoor van de toenmalige Holland Amerika Lijn. Ooit begonnen als handelaar in keramisch sanitair groeit de onderneming steeds verder uit tot internationaal en toonaangevend speler in de sanitaire wereld met een groeiend portfolio aan producten voor de badkamer en het toilet.

About Sanibell.

Sanibell is the customer-oriented partner for specialised sanitary shops but also for (interior) architects, interior designers and project developers. Together, we always come up with the best solution for the customer. With beautiful and up-to-date bathroom furniture and washbasins from the extensive and leading INK collections. Sanibell's furniture collections are carefully produced according to strict Dutch standards and quality requirements and are always available from stock.

We also fulfil customers' most creative furniture wishes with custom-made solutions from sister brand Bliss®. Feel free to ask about the possibilities.

Sanibell designs, develops and manufactures bathroom furniture, washbasins and hand washbasins in porcelain, polystone, quartz, solid surface, ceramic (slabs) and marble. Besides these bathroom furnishings, the extensive collections of mirrors, mirror cabinets and lighting also forms an inseparable part of these stylish collections. These collections excel in design, quality and functionality.

Since 2024, the faucet brand IVY® has been part of Sanibell's product range. Developed entirely in-house, these bathroom taps stand out for their quality, durability, ease of installation, design and affordability. Naturally, Sanibell also has these IVY bathroom faucets in stock. In all colours!

HISTORY

Sanibell was founded in 1978 and had its first warehouse in Rotterdam at what we now call the Kop van Zuid, near the headquarters of the then Holland America Line. Once started as a dealer in ceramic sanitary ware, the company continued to grow into an international and leading player in the sanitary world with a growing portfolio of products for the bathroom and toilet.



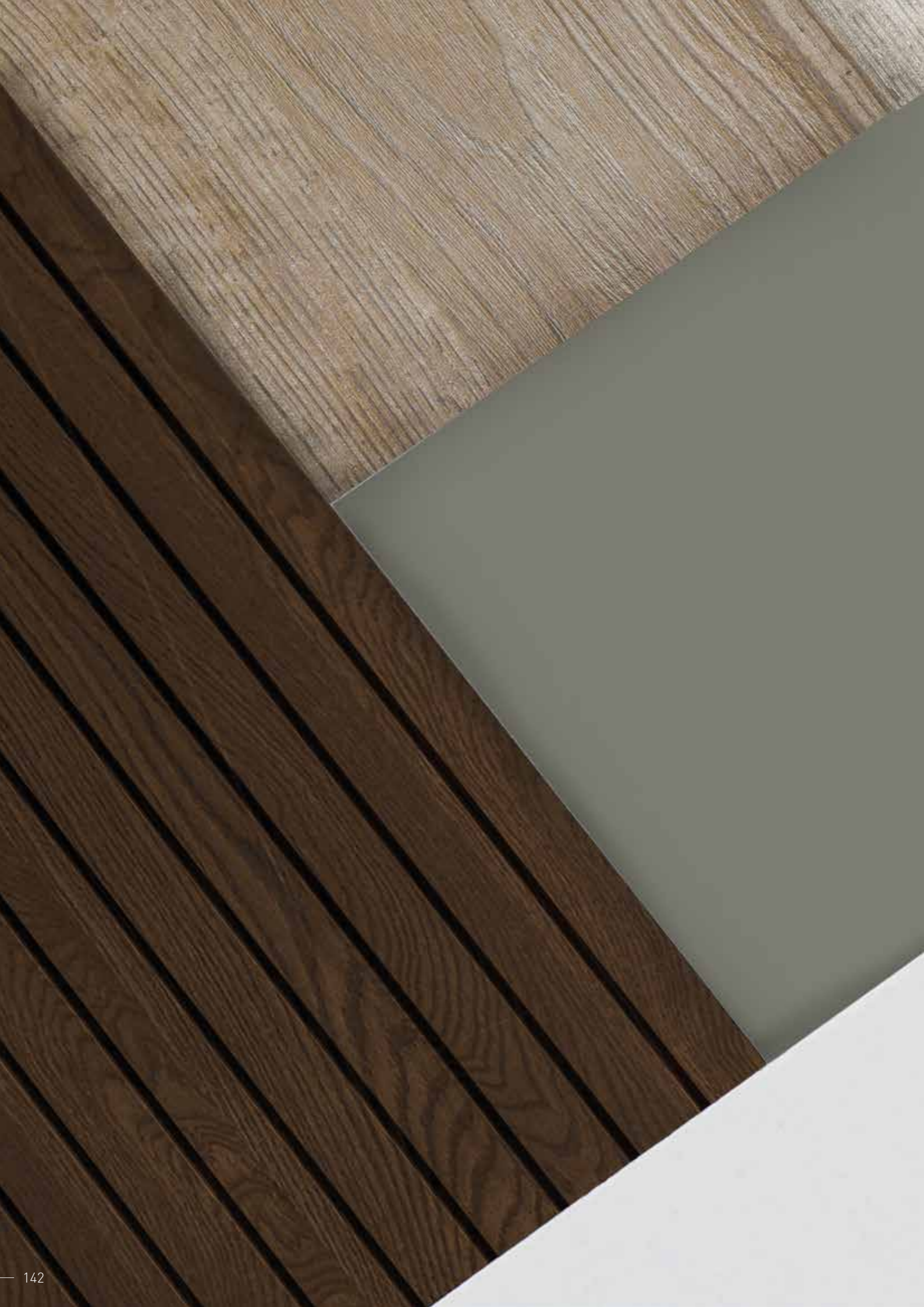

MATERIAAL & ONDERHOUD

MATERIALS & MAINTENANCE

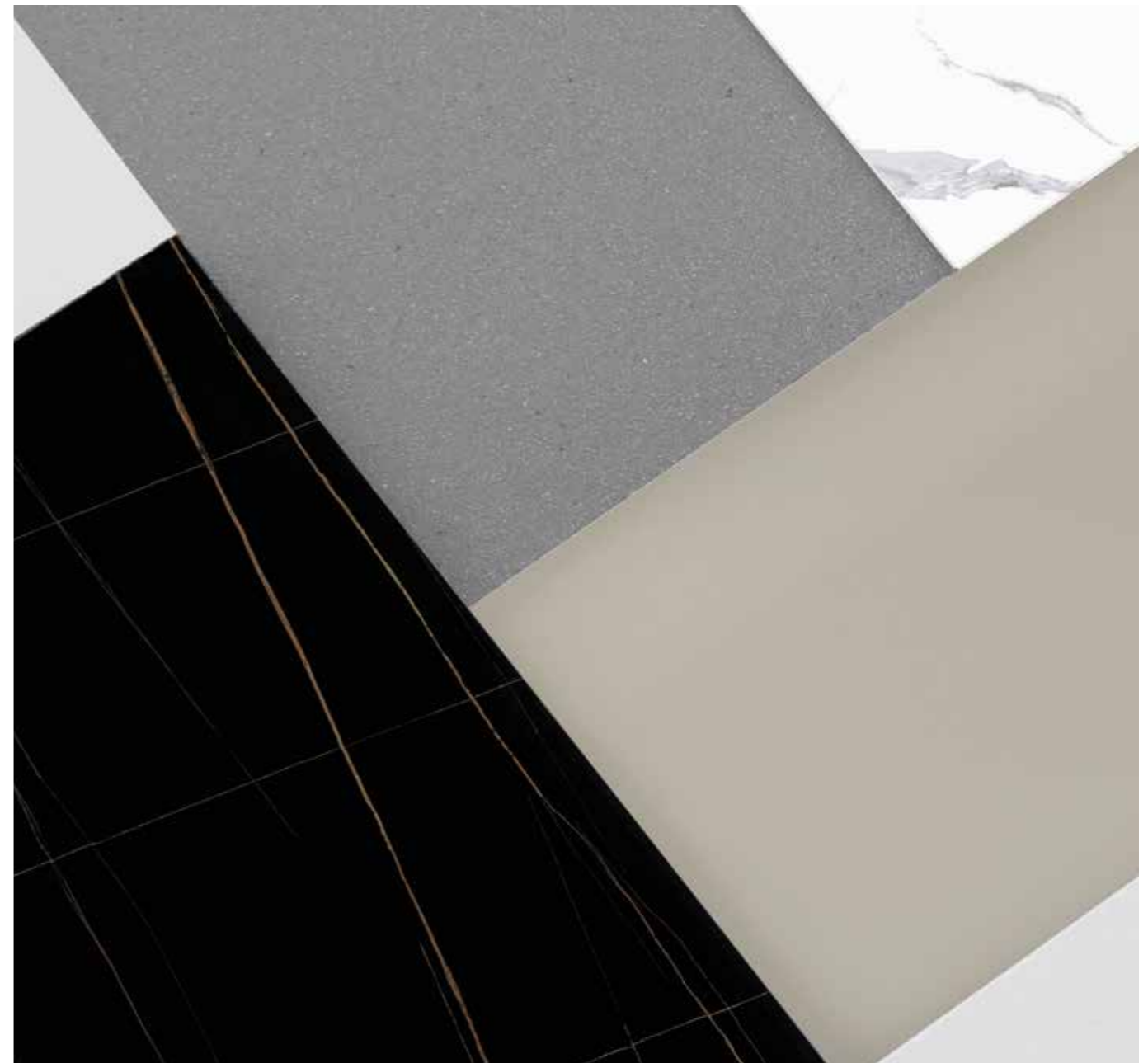

NL

PORSELEIN

Het oppervlak van alle porseleinen wastafels bestaat uit een geglaazuurde, dunne, glasachtige laag.

Porselein kenmerkt zich door de gebruiksvriendelijkheid en het gladde oppervlak. Dat wil niet zeggen dat het ongevoelig is voor beschadigingen. Harde, vallende objecten kunnen het glazuur beschadigen en dat kan leiden tot onherstelbare scheuren en oppervlaktebeschadigingen.

VERWIJDEREN VAN VLEKKEN

Voor de dagelijkse reiniging kunt u normale schoonmaakmiddelen, zoals allesreinigers, voor sanitair gebruiken. Eventuele kalkresten kunnen bijvoorbeeld verwijderd worden met de in de handel verkrijgbare kalkverwijderaars of de reguliere op azijn gebaseerde schoonmaakmiddelen. Deze zijn het minst agressief en het minst schadelijk voor het milieu en onze handen.

Het gebruik van schuurmiddelen op basis van zand wordt afgeraden. Door het veelvuldig schuren met deze middelen wordt de bovenste laag van het glazuur afgeschuurd, waardoor vuil in de toplaag gaat zitten. De polijstmiddelen op basis van krijt kunnen wel normaal op porselein gebruikt worden omdat dit zacht is en dat het een polijstende in plaats van een schurende werking heeft.

REINIGING EN ONDERHOUD

Voor dagelijkse reiniging adviseren we de conventionele schoonmaakmiddelen of schoonmaakmiddelen op basis van azijn. Voor een zachte maar grondige reiniging adviseren wij **Cramer Email Keramik**.

Metalen schaaftplekken, vaak grijze lijnen kunnen makkelijk worden verwijderd met de **Cramer Bath-Rubber**.

BEHANDELING VAN KRASSEN

Porselein is bij normaal gebruik dus heel kraswerend. Maar echte diepe krassen in het oppervlak (meestal het gevolg van een grove botsing met een zwaar of scherp voorwerp) zijn met de gebruikelijke schoonmaakmiddelen niet te verwijderen. Kleine beschadigingen daarentegen kunnen worden hersteld met de **Cramer Touch-up Stick** en het **Cramer Reparatieset** kan worden toegepast bij iets grotere beschadigingen en bijvoorbeeld bij impactschade op de randen van de wasbak.

EN

PORCELAIN

The surface of all porcelain washbasins consists of a glazed, thin, glass-like layer.

Porcelain is characterized by user-friendliness and the smooth surface. That does not mean it is insensitive to damage. Hard falling objects can damage the enamel, which can lead to irreparable cracks and surface damage.

REMOVING STAINS

For daily cleaning you can use normal cleaning agents such as all-purpose cleaners for sanitary facilities.

Any limescale residues can be removed with, for example, the commercially available limescale removers or the regular vinegar-based cleaning products. These are the least aggressive and the least harmful to the environment and our hands.

The use of sand-based abrasives is not recommended. By frequently sanding with these abrasives the top layer of the glaze will be scoured off, leaving dirt in the top layer. The chalk-based polishes are better to use on porcelain because they are soft and have a polishing effect instead of an abrasive effect.

CLEANING AND MAINTENANCE

For daily cleaning, we recommend conventional cleaning agents or vinegar-based cleaning agents. For a gentle but thorough cleaning, we recommend Cramer **Email Keramik**. Metal scrapes, often gray lines, can be easily removed with the **Cramer Bath-Rubber**.

TREATMENT FOR SCRATCHES

Porcelain is very scratch-resistant in regular use. However, really deep scratches in the surface (usually the result of a rough impact with a heavy or sharp object) cannot be removed with the usual cleaning products.

Minor damage, on the other hand, can be repaired with the **Cramer Touch-up Stick**.

The **Cramer Repair Set** can be used for slightly larger damage and, for example, impact damage on the edges of the sink.

Vraag uw sanitair specialist voor meer info over genoemde onderhoudsartikelen of kijk op onze website www.sanibell.nl/shop

Ask your sanitary specialist for more information about the mentioned maintenance items or visit our website www.sanibell.nl/shop

NL

KERAMIEK

Wastafels en afdekplaten van keramiek hebben superieure technische eigenschappen en zijn onderhoudsarm, niet poreus en bijzonder kras- en hittebestendig.

VERWIJDEREN VAN VLEKKEN

Het 100% natuurlijke, keramische tegelmateriaal is gemaakt van granietmaterialen, glasmineralen en natuurlijke oxiden. Deze tegelplaten worden onder extreem hoge druk samengeperst en daarna door een oven op een temperatuur van 1200 graden gevoerd. Dit verdichtingsproces creëert een hard en esthetisch tegelmateriaal dat onderhoudsarm, niet poreus en bijzonder kras – en hittebestendig is.

Dat neemt niet weg dat er geen hete materialen op het werkblad gezet mogen worden. Gebruik altijd een onderzetter om beschadiging of veel poetswerk te voorkomen. Ga vervolgens nooit op een werkblad staan of zitten om, bijvoorbeeld de spiegel boven de wastafel schoon te maken. Het kan bij plaatselijke druk van bovenaf scheuren of barsten.

BEHANDELING VAN VLEKKEN EN ONDERHOUD

Vermijd altijd het contact met agressieve, zure en bijtende middelen in de wastafel. Voor de gebruikelijke huishoudelijke vlekken en het dagelijks onderhoud kunt u met een sopje van gewone allesreiniger of Cif (zonder citroen) al goed uit de voeten. Natuurlijk dient u daarna de wastafel/afdekplaat met voldoende schoonwater na te spoelen. Voor de wat ernstigere vervuiling kunt u Cif (zonder citroen) gebruiken, zo nodig onverdund in combinatie met ruwe kant van een schuursponsje. Altijd met voldoende schoon water naspoelen.

REINIGING EN ONDERHOUD

Voor de dagelijkse reiniging en onderhoud is er ook een specialistisch schoonmaakmiddel voorhanden: Total Clean schoonmaakset bestaat uit een dagelijkse reiniger, een intensieve reiniger en microvezeldoek. Total Clean Daily; de dagelijkse reiniger wordt geleverd in een sprayfles. Deze licht alkalische dagelijkse reiniger is geschikt om lichte tot middelzware vervuiling te verwijderen.

De **Total Clean Intensive** is een sterke reiniger die geschikt is om hardnekkig vuil te verwijderen.

Deze reiniger kan ook gebruikt worden op graniet, marmer, beton en composiet.

EN

CERAMICS

Ceramic washbasins and cover plates have superior technical properties and are low-maintenance, non-porous and particularly scratch and heat resistant.

REMOVING STAINS

The 100% natural ceramic tile material is made of granite materials, glass minerals and natural oxides. These tile plates are pressed together under extremely high pressure and then passed through an oven at a temperature of 1200 degrees. This compaction process creates a hard and aesthetic tile material that is low-maintenance, non-porous and particularly scratch- and heat-resistant.

This does not alter the fact that no hot materials may be placed on the worktop. Always use a trivet to prevent damage or a lot of cleaning. Then never stand or sit on a work surface to, for example, clean the mirror above the sink. It can break or crack under local pressure from above.

TREATMENT FOR STAINS AND SCRATCHES

Always avoid contact with aggressive, acidic and corrosive substances on the washbasin. For the usual household stains and daily maintenance, you can use a solution of ordinary all-purpose cleaner or Cif (without lemon). Of course you should then rinse the washbasin/cover with sufficient clean water. For the more serious stains you can use Cif (without lemon), if necessary undiluted in combination with the rough side of a scouring pad. Always rinse with plenty of clean water.

CLEANING AND MAINTENANCE

A specialist cleaning product is also available for daily cleaning and maintenance: Total Clean cleaning set consists of a daily cleaner, an intensive cleaner and a microfibre cloth. Total Clean Daily; the daily cleaner comes in a spray bottle. This slightly alkaline daily cleaner is suitable for removing light to medium soiling.

The Total Clean Intensive is a strong cleaner that is suitable for removing stubborn dirt.

This cleaner can also be used on granite, marble, concrete and composite.

Vraag uw sanitair specialist voor meer info over genoemde onderhoudsartikelen of kijk op onze website www.sanibell.nl/shop

Ask your sanitary specialist for more information about the mentioned maintenance items or visit our website www.sanibell.nl/shop

NL POLYSTONE

Polystone wastafels hebben een basis van minerale vulstoffen en een polyester/epoxy bindmiddel en zijn voorzien van een harde kunststof toplaag (gelcoat). Ze zijn gemakkelijk schoon te maken en schoon te houden met water en de gebruikelijke in de supermarkt verkrijgbare huishoudelijke reinigingsmiddelen.

VERWIJDEREN VAN VLEKKEN

Vlekken zijn door het gladde oppervlak eenvoudig te verwijderen met een vochtige doek of gewoon met water en een vloeibaar afwas- of reinigingsmiddel. Gebruik geen chemische middelen zoals bijvoorbeeld bleekwater, haarverf of nagellakverwijderaar/acetone. Deze middelen kunnen de wastafel onherstelbaar beschadigen en/of verkleuren.

Opmerking: puntige vallende voorwerpen kunnen het oppervlak beschadigen. Minerale gegoten composieten zijn gevoeliger voor krassen dan keramiek/porselein en zijn niet bestand tegen temperaturen die continu hoger zijn dan 65 graden Celsius.

Moeilijk te verwijderen vlekken en lichte, oppervlakkige krassen kunnen ook verwijderd worden met behulp van de **Cramer Acryl-Mineral**. De **Cramer Touch-up Stick** en de **Cramer Reparatieset** kunnen worden toegepast bij kleine beschadigingen.

REINIGING EN ONDERHOUD

Mineraal gegoten composieten mogen alleen worden gereinigd met een zachte spons/doek en een zandvrije vloeibare reiniger of het speciale poetsmiddel: **Cramer Acryl-Mineral** en reinigingsmiddel: **Cramer Mineral-Cast-Cleaner**.

EN POLYSTONE

Polystone washbasins have a base of mineral fillers and a polyester / epoxy binder and are provided with a hard plastic top layer (gelcoat). They are easily cleaned and kept clean with water and common household cleaners available in the supermarket.

REMOVING STAINS

Due to the smooth surface, stains can easily be removed with a damp cloth or simply with water and a liquid dishwashing or cleaning agent. Do not use chemicals such as bleach, hair dye or nail polish remover / acetone. These agents can irreparably damage and / or discolour the washbasin.

Note: Pointed falling objects can damage the surface. Mineral cast composites are more susceptible to scratches than ceramic / porcelain and cannot withstand temperatures that are continuously higher than 65 degrees Celsius.

Difficult to remove stains and light superficial scratches can be removed with the help of the **Cramer Acryl-Mineral**.

The **Cramer Touch-up Stick** and the **Cramer Repair Set** can be used for minor damage.

CLEANING AND MAINTENANCE

Mineral cast composites should only be cleaned with a soft sponge / cloth and a sand-free liquid cleaner or the special polish: **Cramer Acryl-Mineral** and cleaning agent: **Cramer Mineral-Cast-Cleaner**.

Vraag uw sanitair specialist voor meer info over genoemde onderhoudsartikelen of kijk op onze website www.sanibel.nl/shop

Ask your sanitary specialist for more information about the mentioned maintenance items or visit our website www.sanibel.nl/shop

NL QUARTZ

De Quartz wastafelbladen zijn gemaakt van een zogenaamd composiet steen. Dat wil zeggen: het bestaat voor ruim 93% uit natuurlijke quartzkorrels en voor 7% uit een gepigmenteerd kunststof bindmiddel.

VERWIJDEREN VAN VLEKKEN

Het is belangrijk om gemorste producten direct met ruim voldoende warm water te verwijderen. Het moet voorkomen worden dat het de steen aantast. Gebruikelijke zachte huishoudmiddelen en een microvezeldoekje zijn hierbij gewoon te gebruiken. Gebruik geen bijtende of agressieve schoonmaakmiddelen. Het is belangrijk om het oppervlak na gebruik goed af te drogen met een schone, zachte doek.

Opmerking: ook een waterontharder kan het oppervlak beschadigen. De waterontharder dient op DH3 te worden ingesteld.

BEHANDELING VAN KRASSEN

Zoals bij elke steensoort kunnen scherpe voorwerpen krasjes achter laten. Vaak herkenbaar als witte sporen. Deze zijn licht op te wrijven met een zogenaamde wonderspons die bij elke drogist maar ook in de webshop te verkrijgen is. Wrijf met de spons in cirkelvormige bewegingen tot dat de kras niet meer opvalt. De Quartz wastafels zijn vanuit de fabriek behandeld met een beschermende coating. Wij adviseren u het product regelmatig te onderhouden met de speciaal daarvoor ontwikkelde producten.

Reiniging en onderhoud

Voor de reiniging en onderhoud van quartz oppervlakken is er een speciale **Tenax Care Kit (Enhancer effect)** beschikbaar. De **Tenax Care Kit (Enhancer effect)** bevat:

BOOSTER ALK EASY (ALKALISCH ONTVETTEND MIDDEL VOOR HET VERWIJDEREN VAN HET MEEST HARDNEKKIG VUIL – 150 ML SPRAY): te gebruiken bij organische en anorganische vlekken en bijzonder hardnekkig vuil (zoals was, olie, vet, wijn, cola, dagelijkse voedselvlekken, fruitvlekken, vingerafdrukken, enz.) die niet verwijderd kunnen worden met producten voor de normale reiniging van oppervlakken.

BRIOTOP (GEBRUIKSKLAAR UNIVERSEEL REINIGINGSMIDDEL – 150 ML SPRAY): gebruiksklaar universeel reinigingsmiddel voor een eenvoudige en snelle reiniging van alle oppervlakken

QUARTZ TONER (UNIVERSEEL KLEURHERSTELLEND BESCHERMINGSMIDDEL OP BASIS VAN OPLOSMIDDEL.

GOEDGEKEURD VOOR CONTACT MET LEVENSMIDDELEN (VERORDENING EG 1935/2004) – 150 ML FLACON): Na buitengewone reinigingswerkzaamheden aan de oppervlakken is het raadzaam de bescherming ervan te herstellen. De Toner zorgt voor het herstel van het oppervlak en doet de kleur herleven. Bovendien beschermt het tegen vlekken zonder de natuurlijke eigenschappen van het materiaal aan te tasten.

EN QUARTZ

The Quartz washbasins are made of a so-called composite stone. This means that it consists of more than 93% natural quartz granules and 7% of a pigmented synthetic binder.

REMOVING STAINS

It is important to remove spilled products immediately with plenty of warm water. It must be prevented from affecting the stone. Conventional soft household products and a microfibre cloth can be used for this. Do not use caustic or aggressive cleaning agents. It is important to dry the surface well with a clean, soft cloth after use.

Note: A water softener can also damage the surface. The water softener should be set to DH3.

TREATMENT FOR SCRATCHES

As with any type of stone: sharp objects can leave scratches. Often recognizable as white lines. These can be lightly rubbed with a so-called miracle sponge that is available at every drugstore. Rub the sponge in circular movements until the scratch is no longer noticeable. The Quartz washbasins are treated with a protective coating from the factory. We advise you to maintain the product regularly with the specially developed products.

CLEANING AND MAINTENANCE

A special **Tenax Care Kit (Enhancer effect)** is available for cleaning and maintaining quartz surfaces. The **Tenax Care Kit (Enhancer effect)** contains:

BOOSTER ALK EASY (ALKALINE DEGREASING AGENT FOR REMOVING THE MOST STUBBORN DIRT – 150 ML SPRAY): for use on organic and inorganic stains and particularly stubborn dirt (such as wax, oil, grease, wine, cola, everyday food stains, fruit stains, fingerprints, etc.) that cannot be removed with products for normal surface cleaning.

BRIOTOP (READY-TO-USE UNIVERSAL CLEANING AGENT – 150 ML SPRAY): ready-to-use universal cleaning agent for easy and quick cleaning of all surfaces

QUARTZ TONER (UNIVERSAL COLOUR-RESTORING PROTECTIVE AGENT BASED ON SOLVENTS.

APPROVED FOR CONTACT WITH FOOD (REGULATION EC 1935/2004) – 150 ML BOTTLE): After exceptional cleaning work on surfaces, it is advisable to restore their protection. The Toner restores the surface and revives the colour. It also protects against stains without affecting the natural properties of the material.

Vraag uw sanitair specialist voor meer info over genoemde onderhoudsartikelen of kijk op onze website www.sanibel.nl/shop

Ask your sanitary specialist for more information about the mentioned maintenance items or visit our website www.sanibel.nl/shop

NL

MASSIEF EIKEN / EIKEN FINEER

Onze met echt eikenhout gefineerde meubelen worden voorzien met een matte laklaag in de kleur Natur of met een twee componentencoating van Rubio Monocoat Oil in de kleuren Aqua, Ash grey, Chocolate of Charcoal. De meubelen die voorzien zijn van massieve panelen hebben alleen een coating van Rubio Monocoat in de hierboven genoemde kleuren.

Bij het onderhoud van deze meubelen wordt een onderscheid gemaakt tussen meubelen die naturel (vernisl) gelakt zijn. Dat zijn alleen de gefineerde meubelen. Deze transparant gelakte fineer meubelen in de kleur Natur vergen eigenlijk geen onderhoud. Vernis is een kleurloze laag die over alle zijden van het hout wordt aangebracht, waardoor het waterdicht wordt. Eigenlijk is het meubel geplastificeerd, waardoor de eigenschappen van de lak of vernis het meubel beschermen. Houd er rekening mee dat bij beschadiging van de vernislaag het hout weer vocht op kan nemen. Krassen, beschadigingen of vlekken zijn helaas niet zelf te verwijderen.

De meubelen die voorzien zijn van een twee componenten Rubio Monocoat Oil - dit kunnen zowel de meubelen zijn die gefineerd zijn en de meubelen met massieve eikenhouten panelen - zijn er speciale onderhoudsproducten beschikbaar.

ALGEMEEN DAGELIJKS ONDERHOUD

Echt hout (massief of fineer) dient schoongemaakt te worden met een zachte droge doek. Daarbij dienen schurende en/of scherpe voorwerpen vermeden te worden.

Voor het verwijderen van hardnekkig vuil gebruikt men een vochtige doek met warm water en een mild reinigingsmiddel. De oppervlakte dient altijd na reiniging gedroogd te worden. Gebruik bij reiniging nooit schurende, zuur- of oplosmiddel houdende of vethoudende reinigingsmiddelen.

Als het meubel nat wordt, droog deze dan zo snel mogelijk. Laat het meubeloppervlak nooit nat of vochtig voor langere perioden. Bij langdurig overmatig contact met water kunnen er witte plekken in het hout ontstaan. Dan is het vocht in het hout gekomen en gaat het 'open' staan. Tevens kunnen er dan kalkvlekken in het hout ontstaan. Daarnaast kunnen bij eiken zwarte vlekken ontstaan wanneer het in contact komt met metalen. Het metaal reageert op het looizuur wat in het eikenhout aanwezig is. Denk hierbij aan metalen potjes en ook bijvoorbeeld parfum waar ook metaaldeeltjes in zitten.

Gemorste chemicaliën zoals ontkalkingsmiddelen, nagellak remover, haarkleuringen etc. dienen zo snel mogelijk verwijderd te worden. Beschadigingen zoals krassen op massieve, gefineerde of gelakte oppervlakten zijn minder waterbestendig. Om opzwellling te voorkomen is dan extra voorzichtigheid geboden.

RUBIO MONOCOAT EASY CARE SET (VLEKKENSET)

Deze set bevat 4 x 100ml flesjes: Monocoat Tannin Remover, Grease Remover, Limespot Remover en de Soap.

SOAP: Geconcentreerd, uiterst economisch qua verbruik.

TANNIN REMOVER: Zwarte/looizuur vlekken (bv. kringen/vlekken van blikjes, bloempotten). Kan ook ingezet worden na waterschade. Kan zowel gebruikt worden op onbehandelde, geoliede als gewaxte oppervlakken.

LIMESPOT REMOVER: Kalkvlekken en andere alkalische vlekken (bv. urine, meststoffen, roestvlekken, chauffagewater). Kan ook ingezet worden bij witte kringen.

GREASE REMOVER: Vetvlekken (bv. olijfolie, frietvet, chips, olie).

Zo snel mogelijk na het ontstaan van de vlek aanbrengen, om het indringen van de vlek te voorkomen.

BEHANDELING VAN KRASSEN EN BESCHADIGINGEN – FINEER MET NATUREL LAK OF FINEER MET RUBIO COATING

Bij de behandeling van krassen in gefineerde meubelen wordt een onderscheid gemaakt tussen meubelen die met naturel vernis gelakt (kleur Natur) zijn en meubelen die voorzien zijn van een twee componenten Rubio Monocoat Oil in de kleuren Aqua, Ash grey, Chocolate of Charcoal.

Krassen en vlekken op gelakte of gecoatete massieve of gefineerde houten meubelen moeten zo snel mogelijk worden behandeld cq gerepareerd zodat er geen verdere schade aan de oppervlakken ontstaat. Gelakte en gefineerde oppervlakten verouderen en kleur kan naarmate de tijd verstrijkt veranderen. Dat is een natuurlijk proces en niet tegen te gaan. Het continu blootstellen aan UV straling (zoals direct zonlicht) kan wel de kleurverandering versnellen.

Geen boom is hetzelfde. Onze met knotty oak gefineerde of de massief eiken meubelen kunnen soms wat kleurverschillen hebben in de onderlinge kasten. Deze mogelijke kleurverschillen zijn vaak eenvoudig zelf op te lossen met het Rubio Monocoat onderhoudspakket in de kleur van uw meubel. Met een paar druppels olie op een doekje kleurt u het meubel zelf makkelijk bij.

BEHANDELING VAN KRASSEN

De massieve delen zijn beschermd en gekleurd met een twee componenten Rubio Monocoat Oil. De volledig massieve eiken panelen zijn altijd op te schuren en kunnen dan voorzien worden van een nieuwe laag.

RUBIO MONOCOAT ONDERHOUDSPAKKET VOOR MEUBELEN

Verkrijgbaar in de kleur van uw meubel: Aqua, Ash grey, Chocolate en Charcoal.

Deze set bevat:

REFRESH (SPRAY 400 ML) ; Voor het oprispen van de beschermende Rubio Monocoat Oil Plus 2C afwerklaag en het gladmaken van ruwe plekken. De spray is kleurloos en kan over elke kleur heen gebruikt worden.

OIL PLUS 2C – A (100 ML) ; Oil Pure voor het ophalen van de kleur en het bijwerken van de oorspronkelijke Rubio Monocoat Oil Plus 2C afwerklaag bij bijvoorbeeld krassen en hardnekkige vlekken.

VERNIS



Natur
*Let op!
Geen Rubio
Monocoat
mogelijk.*

RUBIO MONOCOAT



Aqua



Ash grey



Chocolate



Charcoal

Vraag uw sanitair specialist voor meer info over genoemde onderhoudsartikelen of kijk op onze website www.sanibel.nl/shop

Ask your sanitary specialist for more information about the mentioned maintenance items or visit our website www.sanibel.nl/shop

EN

SOLID OAK / VENEER OAK

Our furniture veneered with real oak wood is provided with a matt lacquer layer in the colour Natur or with a two-component coating of Rubio Monocoat Oil in the colours Aqua, Ash grey, Chocolate or Charcoal. The furniture with solid panels only has a coating of Rubio Monocoat in the colours mentioned above.

In the maintenance of this furniture, a distinction is made between furniture that is natural (varnish) lacquered. Those are only the veneered furniture. These transparent lacquered veneer furniture in the colour Natur do not really require any maintenance. Varnish is a colourless layer that is applied over all sides of the wood, making it waterproof. Actually, the furniture is plasticized, so that the properties of the lacquer or varnish protect the furniture. Keep in mind that if the varnish layer is damaged, the wood can absorb moisture again. Unfortunately, scratches, damage or stains cannot be removed yourself.

There are special maintenance products are available for the furniture that is provided with a two-component Rubio Monocoat Oil - this can be both the furniture that is veneered and the furniture with solid oak panels.

GENERAL DAILY MAINTENANCE

Real wood (solid or veneer) should be cleaned with a soft dry cloth.

Abrasive and / or sharp objects should be avoided.

To remove stubborn dirt, use a damp cloth with warm water and a mild cleaning agent. The surface should always be dried after cleaning. Never use abrasive, acid, solvent, or greasy cleaning agents for cleaning.

If the furniture gets wet, dry it as soon as possible. Never leave the furniture surface wet or damp for extended periods.

Prolonged excessive contact with water can cause white spots in the wood. Then the moisture has entered the wood and it will "open".

Lime stains can also form in the wood. In addition, oak can develop black stains when it comes into contact with metals. The metal reacts to the tannic acid present in the oak. Think of metal pots and perfume, for example which also contains metal particles.

Spilled chemicals such as descaling agents, nail polish remover, hair colouring, etc. should be removed as soon as possible.

Damages such as scratches on solid, veneered or painted surfaces are less water resistant. Extra caution is then required to prevent swelling.

RUBIO MONOCOAT EASY CARE SET (STAIN SET)

This set contains 4 x 100ml bottles: Monocoat Tannin Remover, Grease Remover, Limespot Remover and the Soap.

SOAP: Concentrated, extremely economical in terms of consumption.

TANNIN REMOVER: Black / tannic acid stains (eg circles / stains from cans, flower pots). Can also be used after water damage. Can be used on untreated, oiled and waxed surfaces.

LIMESPOT REMOVER: Limespot and other alkaline stains (eg urine, fertilizers, rust stains, heating water). Can also be used for white circles.

GREASE REMOVER: Grease stains (e.g. olive oil, fries fat, chips, oil).

Apply as soon as possible after the stain has developed to prevent the stain from penetrating.

TREATMENT FOR SCRATCHES AND DAMAGE – VENEER WITH NATURAL LACQUER OR VENEER WITH RUBIO COATING

When treating scratches in veneered furniture, a distinction is made between furniture that is lacquered with natural varnish (colour Natur) and furniture that has a two-component Rubio Monocoat Oil in the colours Aqua, Ash grey, Chocolate or Charcoal.

Scratches and stains on lacquered or coated solid or veneered wooden furniture must be treated or repaired as soon as possible so that no further damage occurs to the surfaces. Painted and veneered surfaces age and colour may change over time. This is a natural process and cannot be prevented. Continuous exposure to UV radiation (such as direct sunlight) can speed up the colour change.

No tree is the same. Our furniture veneered with knotty oak or the solid oak furniture can sometimes have some colour differences in the mutual cabinets. These possible colour differences are often easy to solve yourself with the Rubio Monocoat maintenance package in the colour of your furniture. You can easily colour the furniture yourself with a few drops of oil on a cloth.

TREATMENT OF SCRATCHES

The solid parts are protected and coloured with a two component Rubio Monocoat Oil.

The fully solid oak panels can always be sanded and can then be provided with a new layer.

RUBIO MONOCOAT MAINTENANCE PACKAGE FOR FURNITURE

Available in the colour of your furniture: Aqua, Ash grey, Chocolate and Charcoal.

This set contains:

REFRESH (SPRAY 400 ML) ; For refreshing the protective Rubio Monocoat Oil Plus 2C finish and smoothing rough spots. The spray is colourless and can be used over any colour.

OIL PLUS 2C – A (100 ML) ; Oil Pure for retrieving the colour and updating the original Rubio Monocoat Oil Plus 2C finishing layer for, for example, scratches and stubborn stains.

VARNISH



Natur

*Warning!
No Rubio
Monocoat
possible.*

RUBIO MONOCOAT



Aqua



Ash grey



Chocolate



Charcoal

Vraag uw sanitair specialist voor meer info over genoemde onderhoudsartikelen of kijk op onze website www.sanibel.nl/shop

Ask your sanitary specialist for more information about the mentioned maintenance items or visit our website www.sanibel.nl/shop

NL GEMELAMINEERD HOUT

Melamine houtdecor wordt altijd op spaanderplaat aangebracht. Het hout wordt hierbij voorzien van een dun laagje melaminehars in een houtmotief. Dit kan met een glanzende of matte afwerking zijn. Het materiaal wordt door hitte en druk aangebracht. Dankzij de hars blijft de coating hechten op het hout. Melamine badkamermeubels hebben een krasvrij en slijtvast oppervlak.

ALGEMEEN DAGELIJKS ONDERHOUD

Schoonmaken met een zachte droge doek. Voor het verwijderen van hardnekkig vuil gebruikt men een vochtige doek met warm water en een mild reinigingsmiddel. De oppervlakte dient altijd na reiniging gedroogd te worden. Gebruik bij reiniging nooit schurende, zuur- of oplosmiddelhoudende of vethoudende reinigingsmiddelen. Als het meubel nat wordt, droog deze dan zo snel mogelijk. Laat het meubeloppervlak nooit nat of vochtig voor langere perioden.

Gemorste chemicaliën zoals ontkalkingsmiddelen, nagellak remover, haarkleuringen etc. dienen zo snel mogelijk verwijderd te worden. Beschadigingen zoals krassen en scheuren op gelamineerde, gefineerde of gelakte oppervlakten zijn minder waterbestendig. Om opzwellling te voorkomen is dan extra voorzichtigheid geboden. Bij ernstige beschadigingen adviseren wij u een specialist te raadplegen.

BEHANDELING VAN KRASSEN IN GELAKTE MEUBELEN

Diepe krassen in het oppervlak (meestal het gevolg van een grove botsing met een zwaar of scherp voorwerp) zijn met de gebruikelijke schoonmaakmiddelen niet te verwijderen. Kleine beschadigingen daarentegen kunnen worden hersteld met de **König Kantenfix Premium/bijwerkstift/lakstift**. Deze lakstiften zijn verkrijgbaar in de kleuren van de in het assortiment beschikbare badkamermeubelen en zijn geschikt voor het dekkend inkleuren van hoeken, kanten, groeven, lasnaden en `muizetandjes`. De lak is sneldrogend, heeft een hoge dekkracht en is op acrylbasis.

EN LAMINATED WOOD

Melamine wood decor is always applied to chipboard. The wood is provided with a thin layer of melamine resin in a wood motif. This can be with a glossy or matte finish. The material is applied by heat and pressure. Thanks to the resin, the coating sticks to the wood. Melamine bathroom furniture has a scratch-free and wear-resistant surface.

GENERAL DAILY MAINTENANCE

Clean with a soft dry cloth. To remove stubborn dirt, use a damp cloth with warm water and a mild cleaning agent. The surface should always be dried after cleaning. Never use abrasive, acid, solvent, or greasy cleaning agents for cleaning. If the furniture gets wet, dry it as soon as possible. Never leave the furniture surface wet or damp for extended periods.

Spilled chemicals such as descaling agents, nail polish remover, hair colouring, etc. should be removed as soon as possible. Damages such as scratches and cracks on laminated, veneered or painted surfaces are less water resistant. To prevent bloating extra caution is then required. For serious damage we recommend to consult a specialist.

TREATMENT FOR SCRATCHES

Deep scratches on the surface (usually the result of a rough impact with a heavy or sharp object) cannot be removed with the usual cleaning agents. Small damage, on the other hand, can be repaired with the **König Edge Fix Premium / touch-up pen / touch-up pen**. These touch-up pens are available in the colours of the bathroom furniture available in the range and are suitable for the opaque colouring of corners, edges, grooves, welds and `mouse teeth`. The lacquer is quick-drying, has a high covering power and is acrylic based.

NL GELAKT HOUT

Hoogglans of mat gelakte badkamermeubelen zijn vervaardigd van MDF. Tijdens het productieproces worden ze voorzien van een laklaag en daarna gepolijst.

ALGEMEEN DAGELIJKS ONDERHOUD

Schoonmaken met een zachte droge doek. Voor het verwijderen van hardnekkig vuil gebruikt men een vochtige doek met warm water en een mild reinigingsmiddel. De oppervlakte dient altijd na reiniging gedroogd te worden. Gebruik bij reiniging nooit schurende, zuur- of oplosmiddelhoudende of vethoudende reinigingsmiddelen. Als het meubel nat wordt, droog deze dan zo snel mogelijk. Laat het meubeloppervlak nooit nat of vochtig voor langere perioden.

Gemorste chemicaliën zoals ontkalkingsmiddelen, nagellak remover, haarkleuringen etc. dienen zo snel mogelijk verwijderd te worden. Beschadigingen zoals krassen op gelakte oppervlakten zijn minder waterbestendig. Om opzwellling te voorkomen is dan extra voorzichtigheid geboden.

EN LACQUERED WOOD

High-gloss or matt lacquered bathroom furniture is made of MDF. During the production process they are provided with a layer of lacquer and then polished.

GENERAL DAILY MAINTENANCE

Clean with a soft dry cloth. To remove stubborn dirt, use a damp cloth with warm water and a mild cleaning agent. The surface should always be dried after cleaning. Never use abrasive, acid, solvent, or greasy cleaning agents for cleaning. If the furniture gets wet, dry it as soon as possible. Never leave the furniture surface wet or damp for extended periods.

Spilled chemicals such as descaling agents, nail polish remover, hair colouring, etc. should be removed as soon as possible. Damages such as scratches on painted surfaces are less water resistant. Extra caution is then required to prevent swelling.

NL FONTEINKRANEN, SIFONS EN AFVOERPLUGGEN

De fonteinkranen, hoekstopkranen sifons en afvoerpluggen zijn vervaardigd van hoogwaardig messing en voorzien van een onderhoudsvriendelijke PED finish (Pulse Electro Deposition).

VERWIJDEREN VAN VLEKKEN

De PED afwerkingen worden verkregen door een proces van elektrodepositie – een industrieel proces dat elektriciteit gebruikt om metaal te coaten – met nikkel, chroom etc. Uiteindelijk sterker en duurzamer dan poedercoating en is zeer krasbestendig.

ALGEMEEN DAGELIJKS ONDERHOUD

Gebruik voor de dagelijkse reiniging van de kranen een zacht doekje dat vochtig is gemaakt met water (indien nodig) wat mild reinigingsmiddel of een beetje zeep. Gebruik nooit reinigingsmiddelen zoals schuurpoeder, vloeibaar schuurmiddel, staalwol, microvezeldoekje of een schoonmaakmiddel dat kalk oplost, zuur is of alcohol of een schuurmiddel bevat.

Kalkaanslag kan worden verwijderd met water met schoonmaakazijn. Gebruik nooit schuurmiddelen, chloor of zoutzuurhoudende schoonmaakmiddelen. Altijd goed naspoelen met water en nadrogen/oppoetsen met een schone en droge doek. Dit is noodzakelijk om de resten van schoonmaakmiddelen goed te verwijderen.

EN COLDWATER TAPS, SIPHONS AND PLUGS

The basin taps, angle valves, siphons and drain plugs are made of high-quality brass and have a maintenance-friendly PED finish (Pulse Electro Deposition).

REMOVING STAINS

The PED finishes are obtained through a process of electrodeposition - an industrial process that uses electricity to coat metal - with nickel, chrome etc. Ultimately stronger and more durable than powder coating and is very scratch resistant.

GENERAL DAILY MAINTENANCE

For daily cleaning of the taps, use a soft cloth moistened with water (if necessary) and some mild detergent or a little soap. Never use cleaning agents such as scouring powder, liquid abrasive, steel wool, microfibre cloth or any cleaning agent that dissolves limescale, is acidic or contains alcohol or an abrasive.

Limescale can be removed with water and vinegar. Never use abrasives, chlorine or hydrochloric acid cleaning agents. Always rinse well with water and dry/polish with a clean and dry cloth. This is necessary to properly remove the residues of cleaning agents.

Vraag uw sanitair specialist voor meer info over genoemde onderhoudsartikelen of kijk op onze website www.sanibell.nl/shop

Ask your sanitary specialist for more information about the mentioned maintenance items or visit our website www.sanibell.nl/shop

Vraag uw sanitair specialist voor meer info over genoemde onderhoudsartikelen of kijk op onze website www.sanibell.nl/shop

Ask your sanitary specialist for more information about the mentioned maintenance items or visit our website www.sanibell.nl/shop

KLEURUITVOERINGEN WASTAFELS & ONDERKASTEN

COLOUR VERSIONS WASHBASINS & CABINETS

Porselein

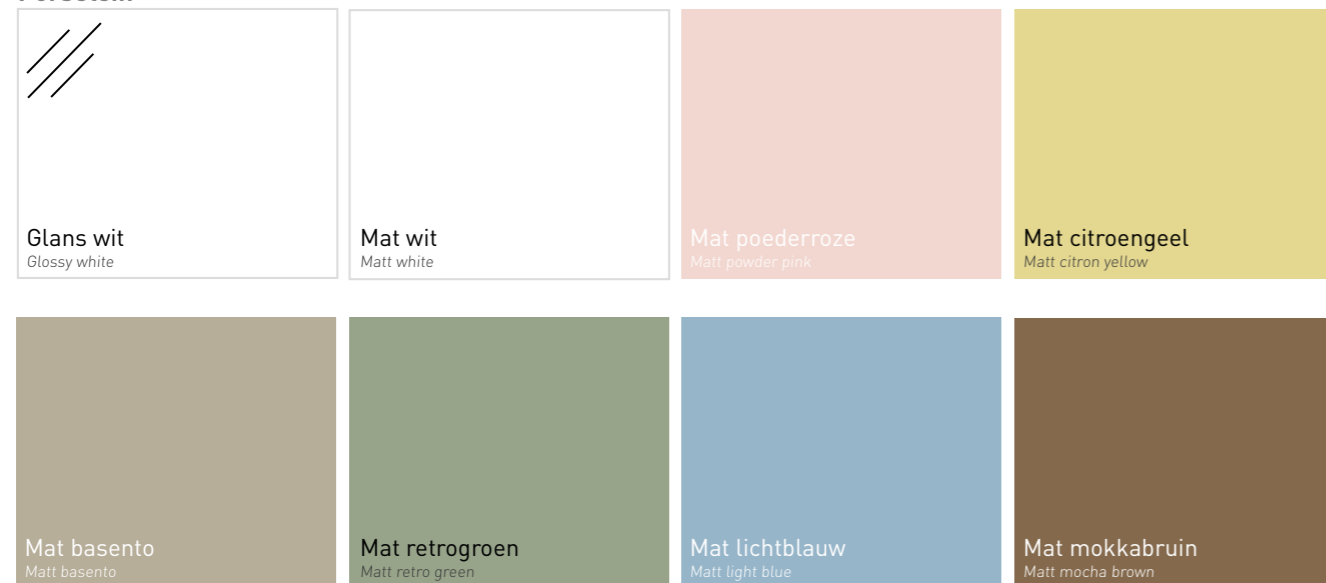

Polystone

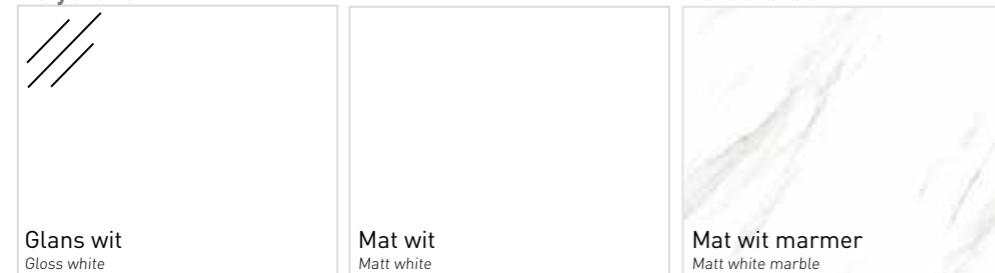

Natuursteen

Quartz



Keramische slab

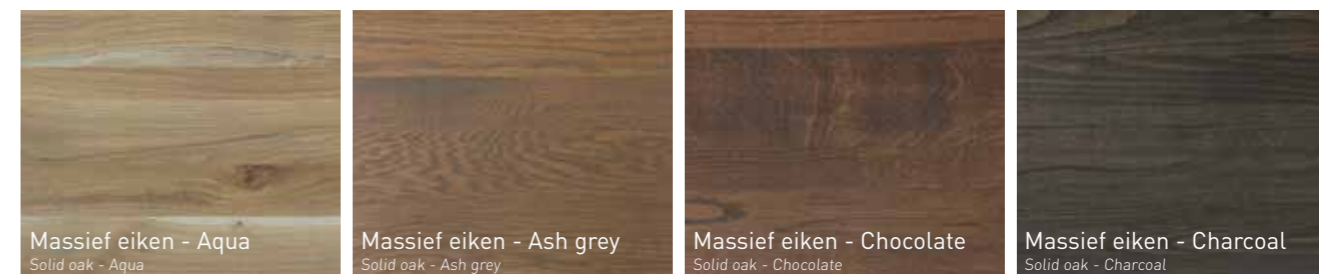
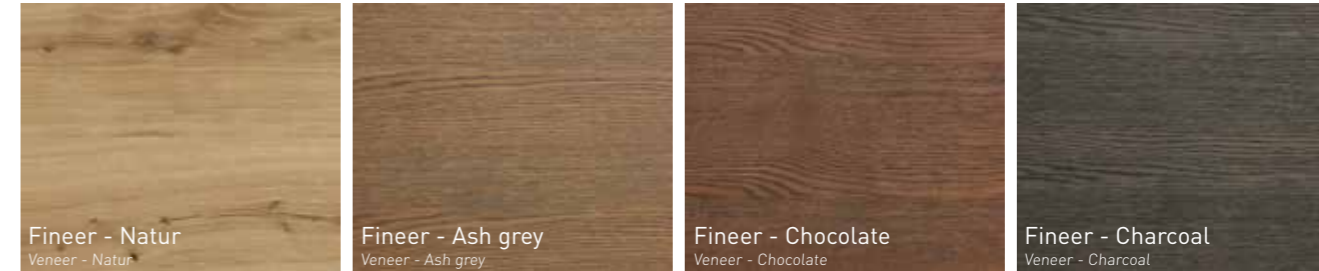
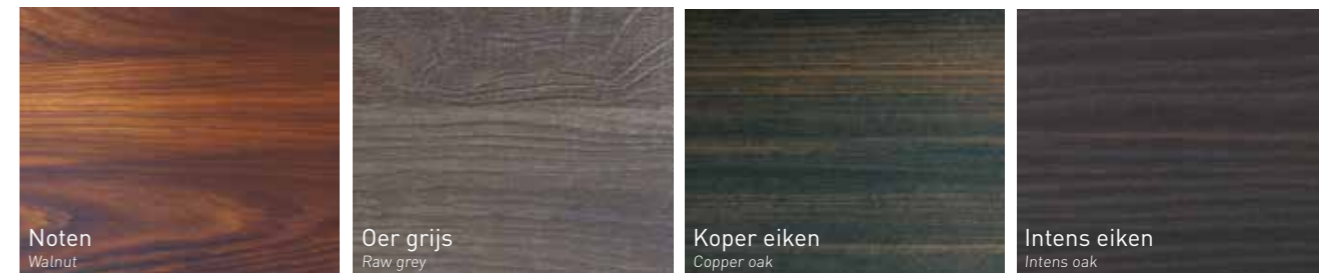
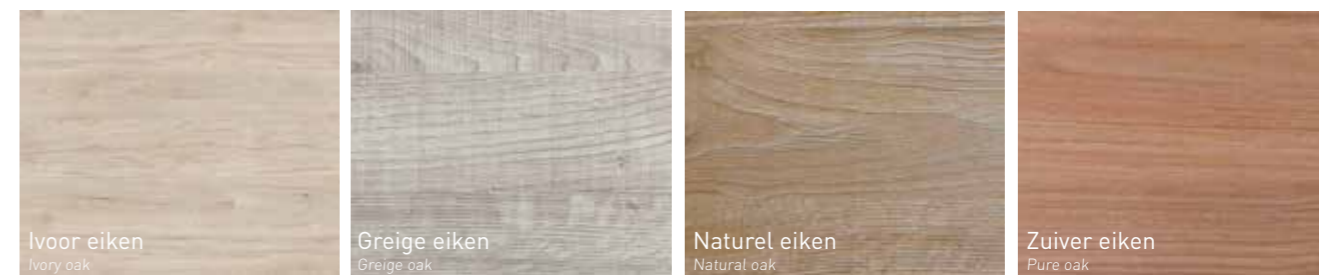

INDEX

A

ASPEKT **34, 35, 36, 37, 73**

B

BLOCC **115, 125**
BREAK **132**

C

CONTRA **107, 121**

D

DISKO **75**
DOCK **22, 23, 28**

E

EASY **102**
ENTER **100, 101, 122**
ENZO **48, 49, 75**

F

FAKTOR **47, 71**

H

HANDY **116, 127**
HANGAR **110, 129**

J

JAZZ LARGE **75**
JAZZ SMALL **30**
JAZZ XS **116, 126, 132**

K

KRAFT **58, 59, 71**

M

MATRIX **103, 123**
MOMENTO **54, 57, 70**
MONO **117, 128**

N

NICE DAY **108, 131**
NICE TIME **108, 131**

O

ONE **132**
OTELLO 24 **132**
OTELLO 40 **38, 39, 41, 75**

P

PITCH **42, 43, 44, 45, 74, 86, 87**
PLAY **104, 105, 130**
POST **46, 74**

R

RECESS **112, 129**
REFLEKT **14, 19, 28**
ROOTS **16, 17, 29**

S

SKYSCRAPER **109, 130**
SMART **111, 127**
SMART XL **60, 61, 81**
SMOOTH **52, 53, 70**
SOUL RECHTHOEK **75**
SOUL ROND **75**
SPIRIT **30**
SWING **30**

T

TEKNO **75**
TOPDECK XS **113, 124**
TOPDECK 40 **24**
TOPDECK 45 **38, 39, 41, 48, 49**

U

UFO **82, 83, 84, 85**
UNIT **20, 21, 29**
UNITED **64, 65, 66, 67, 73**
UNLIMITED **50, 51, 72**
URBAN **62, 63, 72**

V

VERSUS **106, 120**
VICE **128**

Y

YALE **75**

LEGENDA



Inclusief
ruimtebesparende
meubelsifon

*Includes space-saving
furniture siphon*



Greeploos push to open
systeem icm softclose
Blum ladesysteem

*Handleless push to open
system in combination with
soft close Blum drawer system*



SOFT
CLOSE Softclose Hettich
ladesysteem

*Softclose Hettich
drawer system*



Uitsparing voor sifon
in de bovenlade

*Recess for siphon in top
drawer.*



Geen uitsparing voor
sifon in de lade(n)

*No recess for siphon in
the drawer(s)*



Zelf te monteren panelen

Panels to be assembled by yourself



Sensorschakelaar
verlichting

Lighting sensor switch



Spiegelverwarming
(optioneel)

*Mirror heating
(optional)*



Wastafel ook vrijhangend
te plaatsen

*Washbasin can also be
placed free-hanging*



Wastafel met (verdekte)
overloop

*Washbasin with (concealed)
overflow*



Afmetingen van
binnenbak

*Inner washbasin
measurements*



Keurmerk authenticiek
Italiaans porselein

*Certificate authentic
Italian porcelain*



Dimbaar licht

Dimmable light



Sanibell B.V.

www.inkbadkamermeubelen.nl
www.inkbadkamermeubelen.be



/sanibellbv

/inkbadkamermeubelen



/sanibellbv